

Hence, in hydraulic circuits, the following variables can be used for adjusting the output:

The volumetric flow is changed while maintaining the temperature at a constant level	The temperature is changed while maintaining the volumetric flow at a constant level
⇒ Operation with variable volumetric flow	⇒ Operation with constant volumetric flow
⇒ Control of the flow	⇒ Control of mixing

Control of mixing Control of flow

Both control of the flow (variable volumetric flow) and control of mixing (constant volumetric flow) use two different basic hydraulic circuits.

With control of the flow (variable volumetric flow), the hydraulic circuits used are the following:

- Throttling circuit
- Diverting circuit

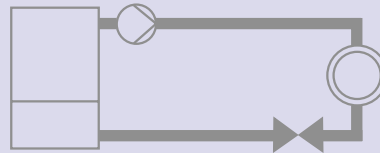

Throttling circuit

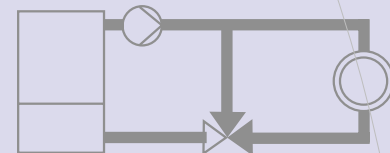

Diverting circuit

Control of mixing

Both hydraulic circuits adjust their outputs by varying the volumetric flow passing through the consumer.

With the control of mixing (constant volumetric flow) the hydraulic circuits used are the following:

- Mixing circuit
- Injection circuit (with a three- or two-port valve)

SIEMENS

Siemens Building Technologies

Hydraulics in building systems

1. Hydraulic circuits	1.1	Key components of a hydraulic plant	5
	1.2	The different hydraulic circuits	6
	1.3	Consumers with their basic hydraulic circuits	8
	1.3.1	Hydraulic circuits with variable and constant flow	8
	1.3.2	Control of flow and control of mixing	9
	1.4	Basic hydraulic circuits	10
	1.4.1	Throttling circuit	10
	1.4.2	Diverting circuit	11
	1.4.3	Mixing circuit	12
	1.4.3.1	Mixing circuit with fixed premixing	13
	1.4.4	Injection circuit	14
	1.4.4.1	Injection circuit with three-port valve	14
	1.4.4.2	Injection circuit with two-port valve	15
	1.5	Components in the consumer circuit	16
	1.5.1	Actuating device	16
	1.5.2	Balancing throttle	17
	1.5.3	Circulating pump	18
	1.6	Headers	19
	1.6.1	The different types of headers	19
	1.6.1.1	Header without main pump (type 1), for consumer zones with mixing circuits	20
	1.6.1.2	Header with main pump (type 2), for consumer zones with throttling circuits or injection circuits with two-port valves	21
	1.6.1.3	Header with main pump (type 3), for consumer zones with diverting circuits or injection circuits with three-port valves	22
	1.6.1.4	Header with main pump (type 4), for differential pressureless consumer connection with mixing circuit	23
	1.6.1.5	Schematic diagrams of headers	24
2. Hydraulic characteristics	2.1	Heat exchanger characteristic and a-value	25
	2.2	Valve characteristic	27
	2.2.1	k_v values	27
	2.2.2	Rangeability S_v	28
	2.2.3	The different valve characteristics	28
	2.3	The characteristic of the controlled system	29
	2.3.1	Valve operating characteristic and valve authority P_v	31
	2.3.2	Oversized valves	33
	2.3.3	Controlling in the low load range	34
	2.4	Network and pump characteristic	35
	2.4.1	Parallel operation of pumps	36
3. Sizing the controlling elements	3.1	Piping sections with variable volumetric flow in different hydraulic circuits	37
	3.2	Valve sizing example	39
	3.2.1	Sizing the valve (controlling element) for the heating zone "Old building"	39
	3.3	Special points to be considered when sizing two- and three-port valves	42
	3.3.1	Impact of total volumetric flow and valve authority P_v with three-port valves	42
	3.3.2	Pressure ratios when sizing two-port valves	44
	3.4	Example of d.h.w. charging control	45
	3.5	Example of air cooling coil control	49

Introduction Heating, ventilation and air conditioning (HVAC) plants are used to create comfortable environmental conditions for human beings.

To satisfy this requirement in our climatic zone, heat – but also cooling energy – must be generated, adequately regulated and delivered to the right place at the right time.

Hydraulic systems are designed to facilitate integration of the required plant components in the circuit between the heat / cooling source and the consumer in a way that optimum operating conditions can be created for the:

- heat / cooling source (temperature, flow of water)
- transportation of the heat / cooling energy carrier such as water or steam (temperature, flow of water)
- integrated control equipment

*Training program
"Hydraulics in building systems"*

The training program "Hydraulics in building systems" offers fundamental training in hydraulics and is aimed at conveying the knowledge required for more advanced hydraulics courses and other training courses in the field of control engineering. The program is designed primarily for experts in the heating and air conditioning sector who deal with hydraulic plants and their components and who want to enhance their knowledge.

"Hydraulics in building systems" – and this documentation – focuses especially on hydraulics on the consumer side.

This does not mean, however, that the heat / cooling source side is less important – the contrary is the case. As a result of the continued technical development of the heat / cooling sources, hydraulic considerations on that side are becoming more and more important also. However, it is not the purpose of the present training program to cover those aspects in detail. But much of the knowledge gained from the consumption side is also applicable to the heat / cooling source side.

The present documentation contains key information of the training modules that constitute part of the training program "Hydraulics in building systems". It is also designed as a piece of accompanying and reference documentation to the training program.

The majority of the graphs and illustrations are taken from the training program. Many of them are animated in the training program and interactive, so you can try for yourself how hydraulic circuits and components behave under different operating conditions.

Training program on CD-ROM

If you are interested in the training program "Hydraulics in building systems", please contact your Siemens sales office.

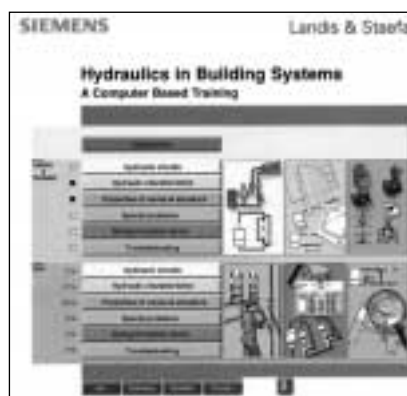

1. Hydraulic circuits

1.1 Key components of a hydraulic plant

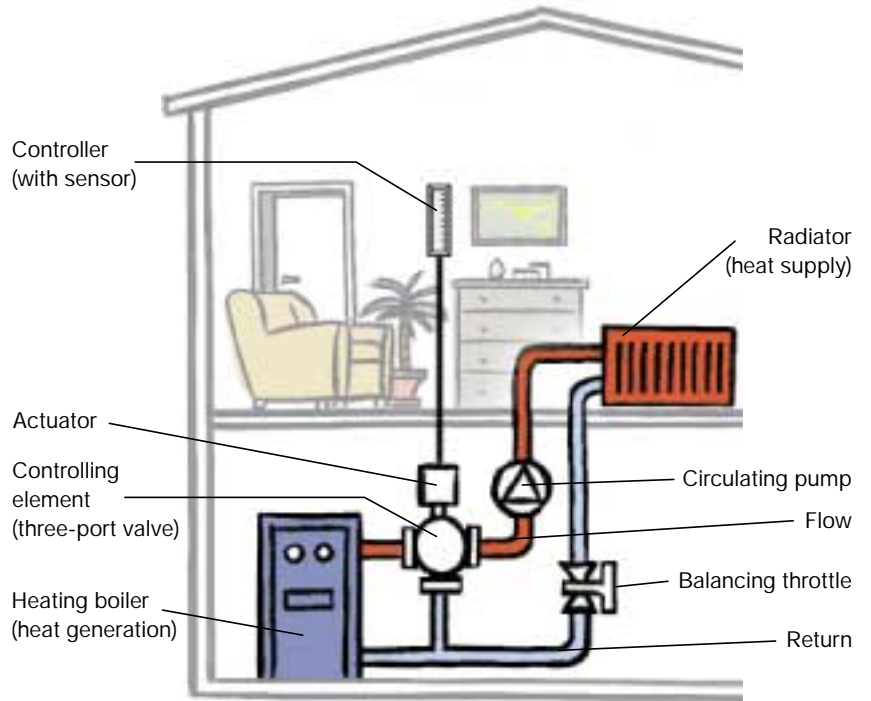

Key components of a hydraulic plant

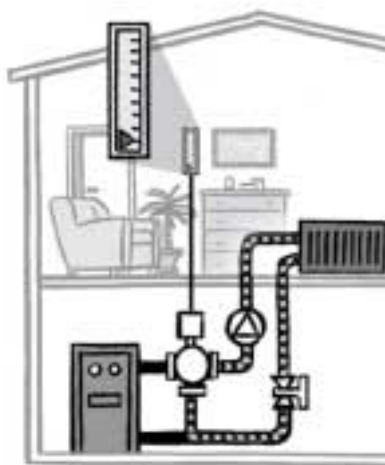

Circulation in a hydraulic plant (valve fully closed)

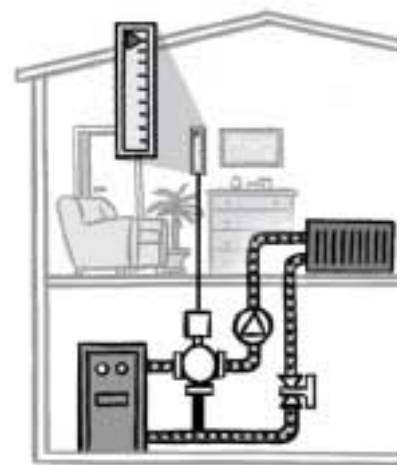

Circulation in a hydraulic plant (valve fully open)

1.2 The different hydraulic circuits

The hydraulic circuits shown thus far are easy to understand. For the expert, however, they are not common practice because they are not suited to explain plant-related interrelationships.

For this reason, it is especially schematic diagrams that are used in the HVAC field. In addition to the representation of plant, they make it easier to understand technical processes and interrelationships.

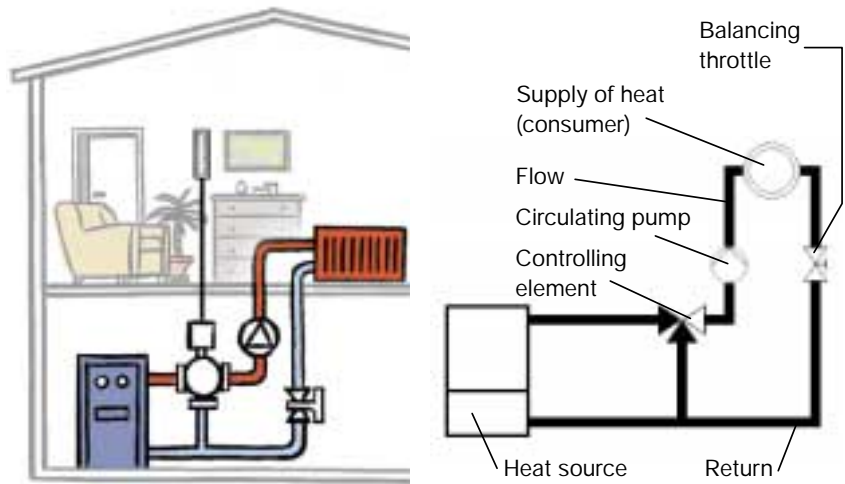

Pictorial diagram of a plant

Schematic diagram of a plant

From the pictorial to the schematic plant diagram

Geographic diagram

Often, the schematic diagram shown above is used for basic plants. It is referred to as a geographic diagram and is closely related to the actual design of the plant.

The geographic diagram is not suited for larger plants, however, because it becomes more and more difficult to understand, especially when interrelationships between consumers and heat / cooling sources are getting complex, e.g. like in the case of a ground water heat pump with storage tank and additional heating boiler that delivers heat to several distributed consumers.

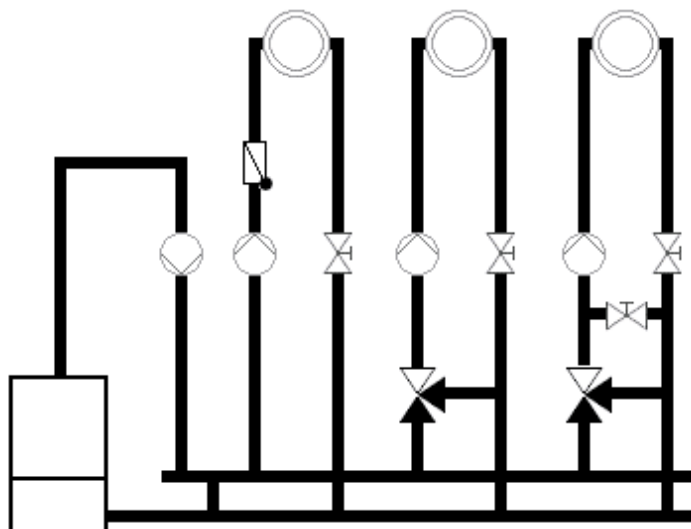

Example of a geographic diagram showing a heating plant with several consumers

For these reasons and due to the extensive use of CAD systems, the kind of diagram frequently used today is a structured diagram.

Synoptic diagram

The synoptic diagram facilitates the schematic representation of very complex and extensive hydraulic plants in a clearly structured and easy-to-understand manner.

With the synoptic diagram, a number of important rules must be observed:

- The flow is shown at the top, the return at the bottom
- Heat / cooling source and consumers are shown parallel in the direction of flow between flow and return

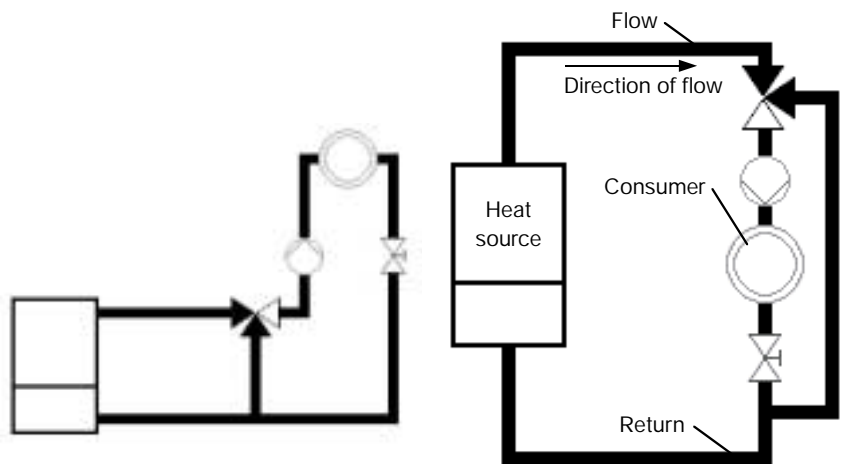

Geographic diagram

Synoptic diagram

Geographical and synoptic diagram of a basic plant

Note on the representation of controlling elements

In the schematic diagrams of hydraulic circuits, it is also important that the correct symbols of a number of plant components be used.

One plant component where this is of particular importance is the three-port controlling element (seat or slipper valve).

The two triangles representing the ports with variable flow must be shown filled, while the triangle representing the port with constant flow must be shown empty.

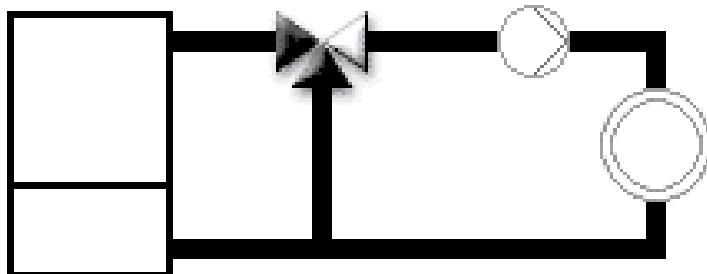

Schematic representation of the valve ports

Triangle filled = variable flow

Triangle empty = constant flow

In a large number of the schematic diagrams contained in the training program "Hydraulics in building systems" and in this documentation, controlling elements are shown without their actuators, the reason being that the diagrams are easier to understand. In addition, the assumption is made that the controlling element is always a valve.

Examples of geographic and synoptic diagrams

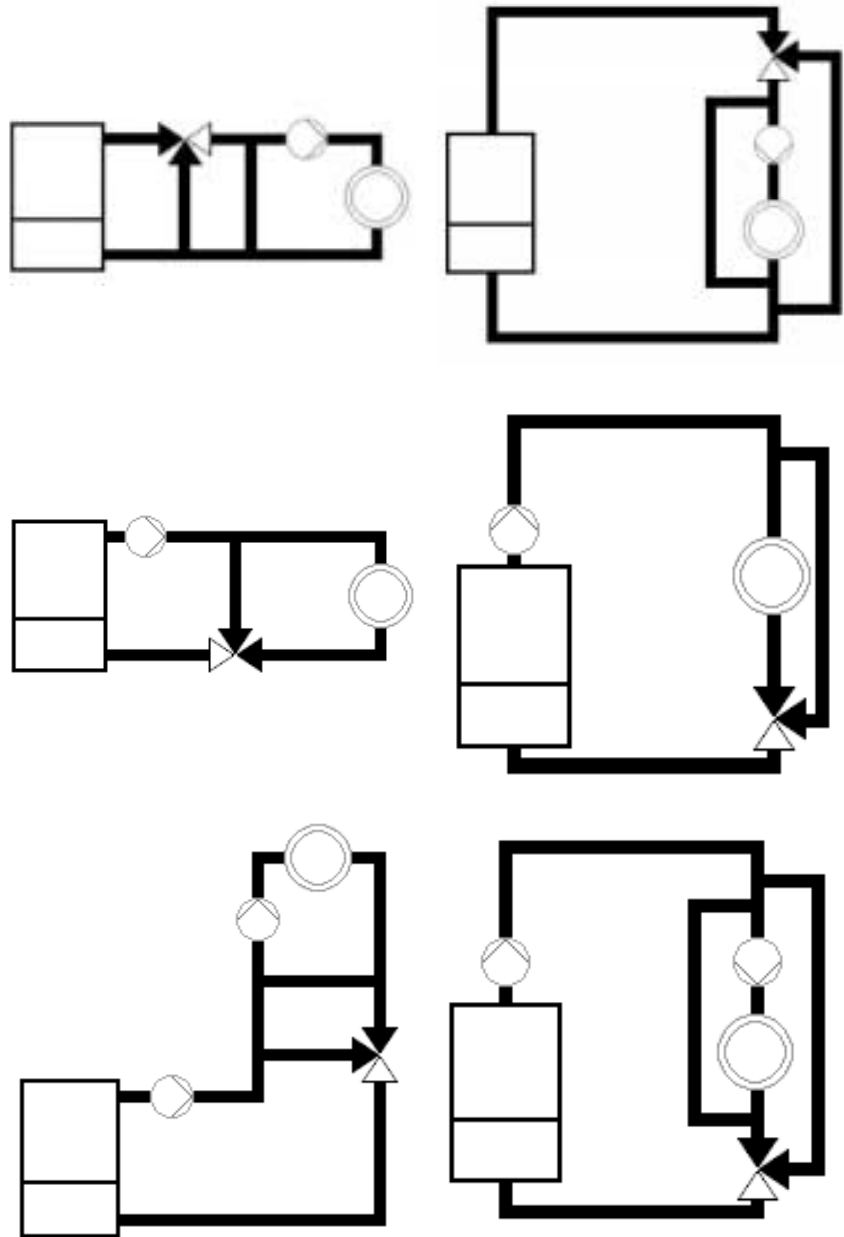

Geographic diagrams

Synoptic diagrams

1.3 Consumers with their basic hydraulic circuits

1.3.1 Hydraulic circuits with variable and constant flow

The output of a heat / cooling source or consumer (amount of heat or cooling energy) is proportional to the product of mass flow and temperature differential across the heat / cooling source or consumer:

$$\dot{Q} = \dot{V} \cdot \Delta T \cdot c \cdot \rho$$

For our considerations and for the standard applications in building services plant, we consider the density ρ and the specific heat capacity c to be constant. This means that the output of a heat / cooling source or consumer is proportional to the product of volumetric flow and temperature differential:

$$\dot{Q} \approx \dot{V} \cdot \Delta T$$

Hence, in hydraulic circuits, the following variables can be used for adjusting the output:

<p>The volumetric flow is changed while maintaining the temperature at a constant level</p> <p>=> Operation with variable volumetric flow</p> <p>=> Control of the flow</p>	<p>The temperature is changed while maintaining the volumetric flow at a constant level</p> <p>=> Operation with constant volumetric flow</p> <p>=> Control of mixing</p>
---	---

1.3.2 Control of flow and control of mixing

Control of flow

Both control of the flow (variable volumetric flow) and control of mixing (constant volumetric flow) use two different basic hydraulic circuits.

With control of the flow (variable volumetric flow), the hydraulic circuits used are the following:

- Throttling circuit
- Diverting circuit

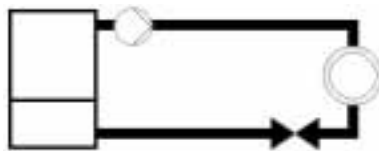

Throttling circuit

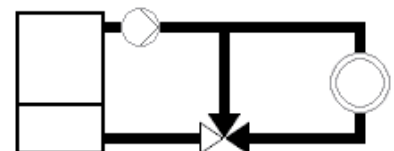

Diverting circuit

Both hydraulic circuits adjust their outputs by varying the volumetric flow passing through the consumer.

Control of mixing

With the control of mixing (constant volumetric flow) the hydraulic circuits used are the following:

- Mixing circuit
- Injection circuit (with a three- or two-port valve)

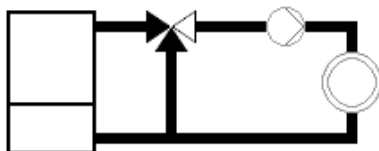

Mixing circuit

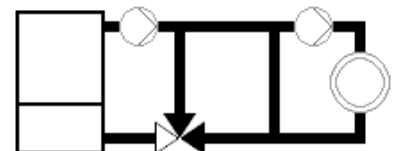

Injection circuit (with three-port valve)

Both hydraulic circuits adjust their outputs by delivering different medium temperatures to the consumer.

1.4 Basic hydraulic circuits

1.4.1 Throttling circuit

Mode of operation

When the valve is adjusted, the volumetric flow will change both in the heat / cooling source section and in the consumer section of the hydraulic circuit. As a result, pressure conditions will greatly vary throughout the system.

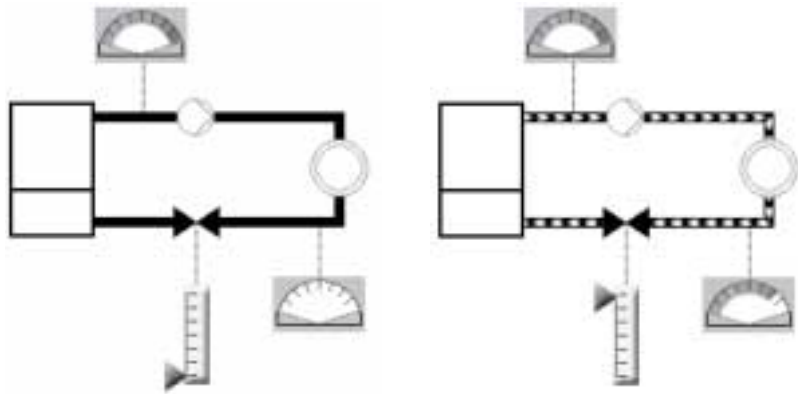

Throttling circuit (valve fully closed)

Throttling circuit (valve fully open)

Characteristics

- Low return temperatures in part load operation
- Variable volumetric flow throughout the entire plant
- On startup, the correct medium temperature will reach the consumer with a certain delay (dead time, depending on the pipe length and the cooling down effect)
- When the valve is fully closed, the pump can reach excessive temperatures (=> use of speed-controlled pumps)

Field of use

- Air heating coils where there is no risk of freezing
- Air cooling coils with dehumidification
- D.h.w. storage tank charging
- District heat connections
- Storage tank charging and discharging
- Plants using condensing boilers

Types of diagrams

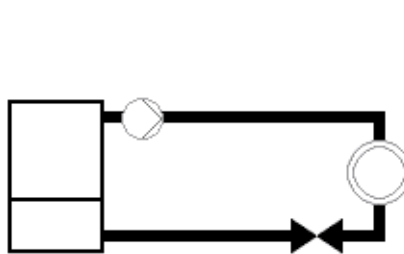

Geographic diagram

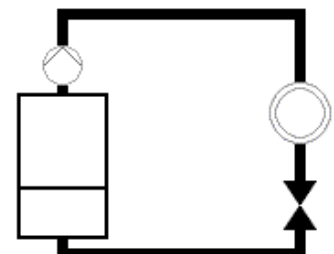

Synoptic diagram

1.4.2 Diverting circuit

Mode of operation

Depending on the position of the valve, a certain proportion of the hot water delivered by the boiler is supplied to the consumer, the rest to the bypass. The output of the consumer is regulated via the volumetric flow. The temperature drop across the consumer is the greater, the smaller the volumetric flow.

When the valve is fully closed, the temperature of the boiler return nearly reaches the temperature of the boiler flow.

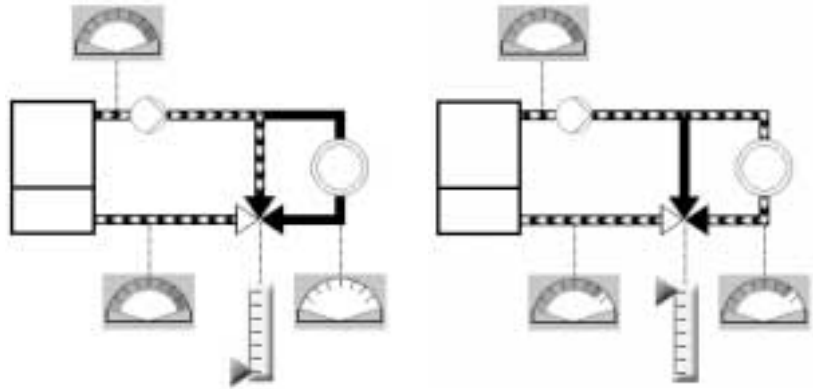

Diverting circuit (valve fully closed)

Diverting circuit (valve fully open)

Characteristics

- Variable volumetric flow through the consumer circuit
- Constant volumetric flow and pressure in the heat / cooling source circuit (advantageous in plants with several zones)
- Medium to high temperatures in the heat / cooling source return
- On startup, the boiler flow temperatures reaches the heat consumer with only little delay (provided the controlling element is rather close to the consumer)

Field of use

- Air cooling coils with dehumidification
- Air heating coils where there is no risk of freezing
- Heat recovery systems
- D.h.w. heating
- Not suited for plants with a district heat connection (high return temperatures)

Types of diagrams

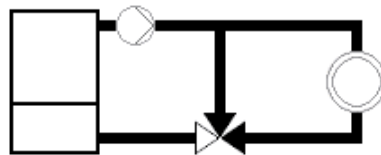

Geographic diagram

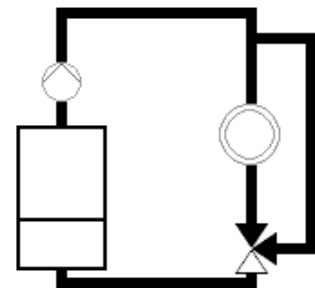

Synoptic diagram

1.4.3 Mixing circuit

Mode of operation

A three-port valve subdivides the hydraulic circuit into a primary or heat source circuit and a secondary or consumer circuit. The hot water delivered by the heat source and the cooler return water are mixed to attain the flow temperature required for the consumer, thereby adjusting the output to meet the demand for heat.

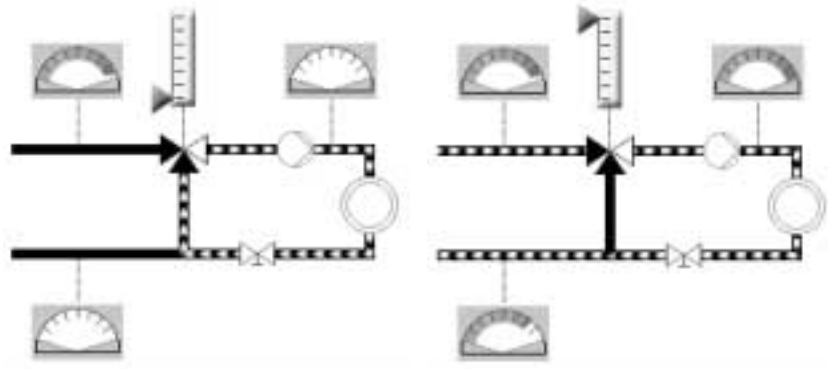

Mixing circuit (valve fully closed)

Mixing circuit (valve fully open)

Characteristics

- Low return temperatures with small loads
- Variable volumetric flow through the heat source circuit
- Constant volumetric flow with variable temperatures through the consumer circuit
- Even temperature distribution across the heat consumer
- Low risk of freezing with air heating coils

The mixing circuit is not suited for plants with distances of more than 20 m between bypass and control sensor. The long transportation time (dead time) makes the control task much more difficult.

Field of use

- Control of radiator systems
- Air heating coils where there is a risk of freezing
- Plants with low temperature heat sources or heat pumps

Types of diagrams

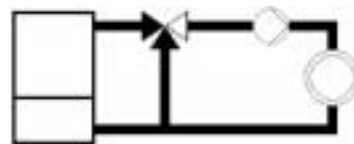

Geographic diagram

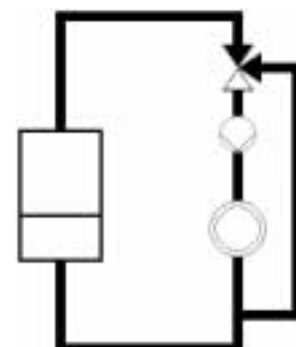

Synoptic diagram

1.4.3.1 Mixing circuit with fixed premixing

Mode of operation

Here too, a three-port valve subdivides the hydraulic circuit into a primary or heat source circuit and a secondary or consumer circuit. Fixed premixing ensures that a certain proportion of cooler return water will always be added to the flow. This is practical when, under design conditions, the required flow temperature to the consumer is considerably lower than the flow temperature delivered by the heat source. It is thus made certain that the three-port valve will operate across its entire correcting span (from the fully closed to the fully open position).

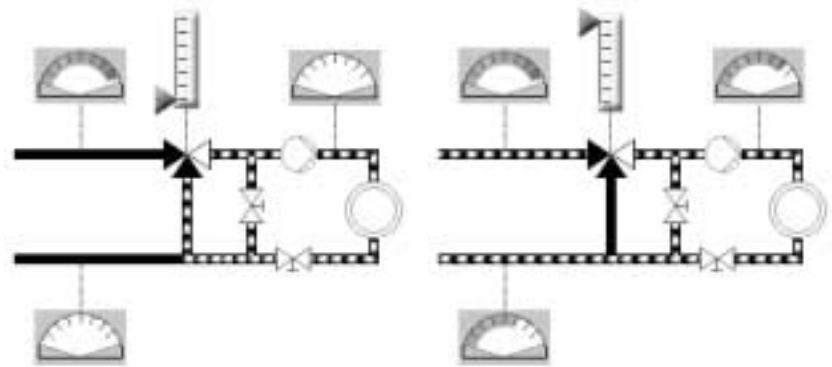

Mixing circuit with fixed premixing
(valve fully closed)

Mixing circuit with fixed premixing
(valve fully open)

Characteristics

- Low return temperatures with small loads
- Variable volumetric flow through the heat source circuit
- Constant volumetric flow with variable temperatures through the consumer circuit

The mixing circuit with fixed premixing is not suited for plants with distances of more than 20 m between bypass and control sensor. The long transportation time (dead time) makes the control task much more difficult.

Field of use

- Consumer circuits where the flow temperature is lower than that of the heat source circuit
- Control of floor and radiator heating systems with low temperature heat sources or heat pumps

Types of diagrams

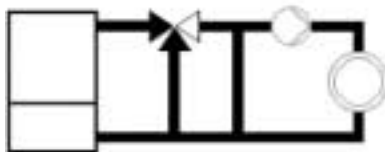

Geographic diagram

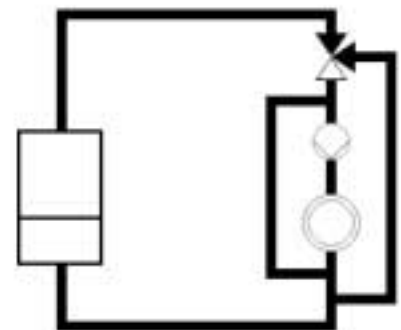

Synoptic diagram

1.4.4 Injection circuit

1.4.4.1 Injection circuit with three-port valve

Mode of operation

The pump to the left produces the pressure required in the heat source circuit, including the pressure drop across the valve, while the pump to the right produces the pressure in the consumer circuit.

The pump in the heat source circuit injects more or less hot flow water into the consumer circuit, depending on the position of the three-port valve. The hot water mixes with cooler return water from the consumer which the consumer pump sucks in via the bypass. As a result, there is a constant volumetric flow with varying temperatures in the consumer circuit.

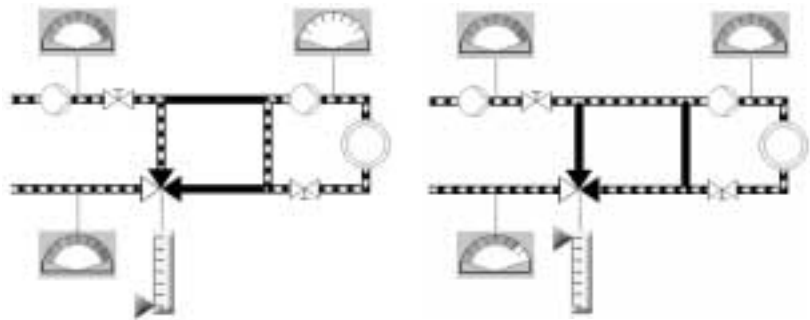

Injection circuit with three-port valve
(valve fully closed)

Injection circuit with three-port valve
(valve fully open)

Characteristics

- Constant volumetric flow in both the heat source and the consumer circuit
- Relatively high return temperatures (corresponding the heat source flow temperature when load = 0 %, and the consumer return temperature when load = 100 %)
- Even temperature distribution across the heat consumer
- Air heating coils with a small risk of freezing

Field of use

- Radiator and floor heating systems
- Air heating coils where there is a risk of freezing
- Air cooling coils without controlled dehumidification
- D.h.w. storage tank charging
- Not suited for plants with district heat connection (high return temperatures)

Types of diagrams

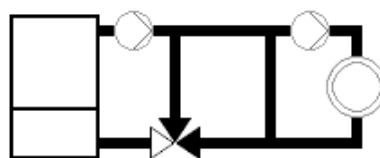

Geographic diagram

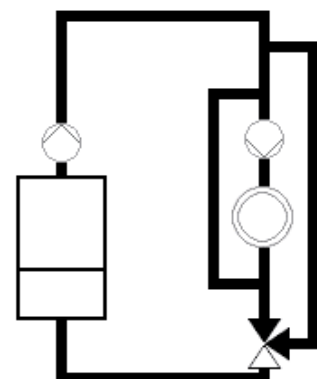

Synoptic diagram

1.4.4.2 Injection circuit with two-port valve

Mode of operation

The pump in the heat source circuit injects more or less hot flow water into the consumer circuit, depending on the position of the two-port valve.

As a result, there is a constant volumetric flow with varying temperatures in the consumer circuit.

In the heat source circuit, by contrast, the volumetric flow and pressure greatly vary, a fact to be taken into consideration in the case of plants consisting of several zones.

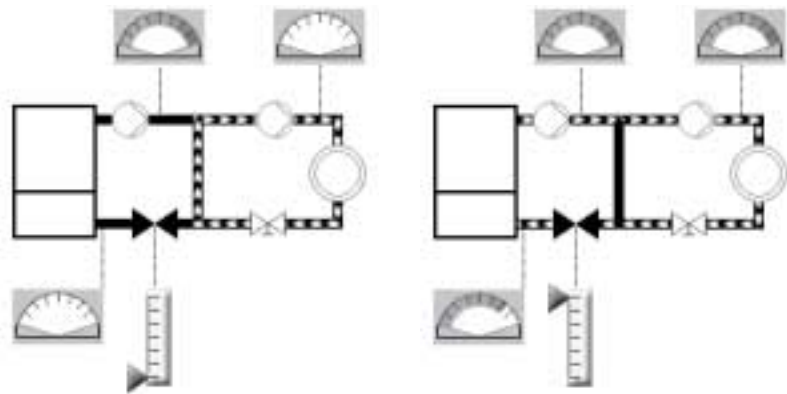

Injection circuit with two-port valve
(valve fully closed)

Injection circuit with two-port valve
(valve fully open)

Characteristics

- Relatively low return temperatures (cold ... consumer return temperature at 100 % load)
- Even temperature distribution across the heat consumer
- Small risk of freezing with air heating coils
- When the valve is fully closed, the pump in the heat source circuit can reach excessive temperatures (=> use of speed-controlled pumps)

Field of use

- Heat storage tanks and heat pumps
- Low temperature boiler plants (condensing boilers)
- Direct district heat connections
- Not suited for air cooling coils with dehumidification control

Types of diagrams

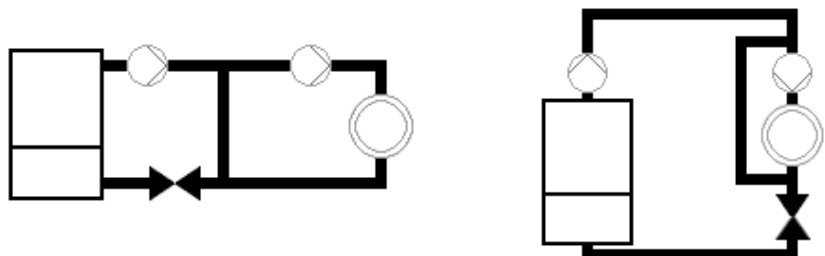

Geographic diagram

Synoptic diagram

1.5 Components in the consumer circuit

In practical applications, the hydraulic circuits discussed above operate correctly only if a number of components are used and installed in the right locations.

Some of these plant components are the following:

- Actuating device
- Circulating pump
- Balancing throttle

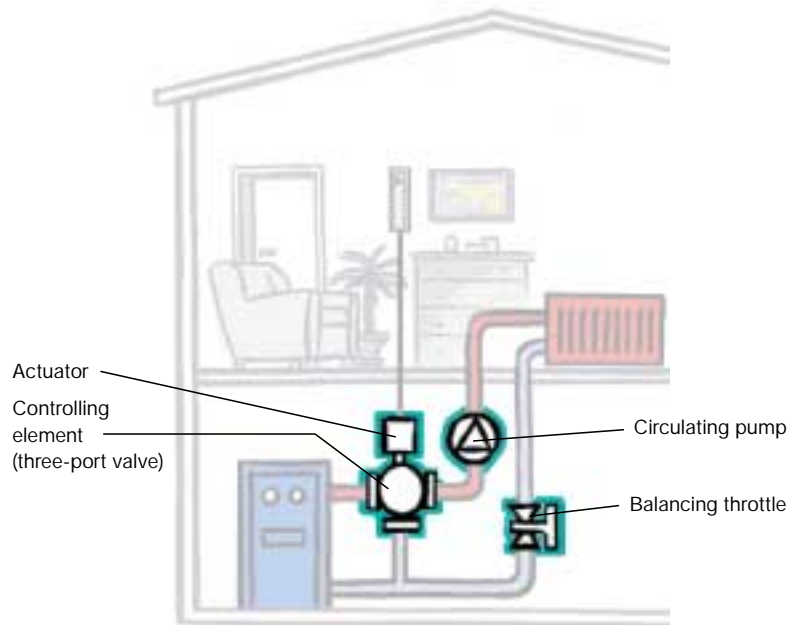

Major components in the consumption circuit

1.5.1 Actuating device

The actuating device consists of controlling element and actuator. The task of the actuating device is to regulate the volumetric flow from the heat source to the consumer in such a way that the supply of heat can be varied between 0 and 100 %. Every controlling element has a controlled port that can be more or less open, or fully open or fully closed.

The controlling elements used in hydraulic circuits are slipper valves (rotary movement) or seat valves (linear movement). The seat valves are divided into:

- Two-port valves
- Three-port valves

Two-port valve

With the two-port valve, the cross-sectional area for the flow is increased or decreased by a change of stroke so that the volumetric flow can be varied to satisfy the demand for heat.

Three-port valve

The three-port valve has a port with a constant volumetric flow. Depending on the use of the valve – mixing or diverting – the change of stroke is different.

Mixing: The delivered volumetric flow remains constant. It is the result of two variable volumetric flows (see illustration below at right).

Diverting: The incoming constant volumetric flow is divided into two variable outlet flows.
 (Note: not all types of three-port valves are suited for use as diverting valves).

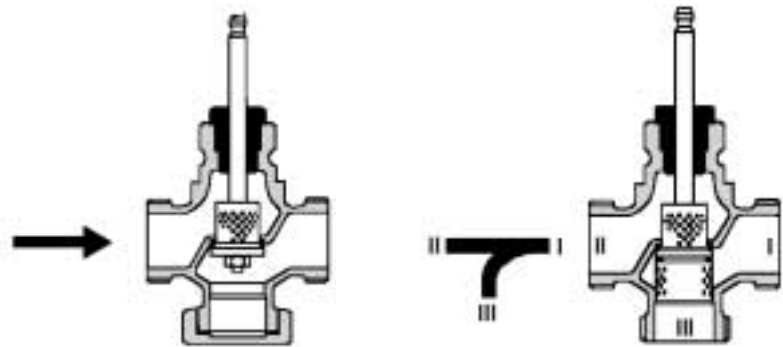

Two-port valve

Three-port valve

Two- and three-port valves as controlling elements
 (designation of ports depending on brand, e.g. A, B, AB)

1.5.2 Balancing throttle

Balancing throttles in the sections of hydraulic circuits with a constant volumetric flow are used during commissioning to adjust the calculated nominal volumetric flow.

Hydraulic balancing

The procedure is called hydraulic balancing. It is an important prerequisite for ensuring the correct functioning of plant.

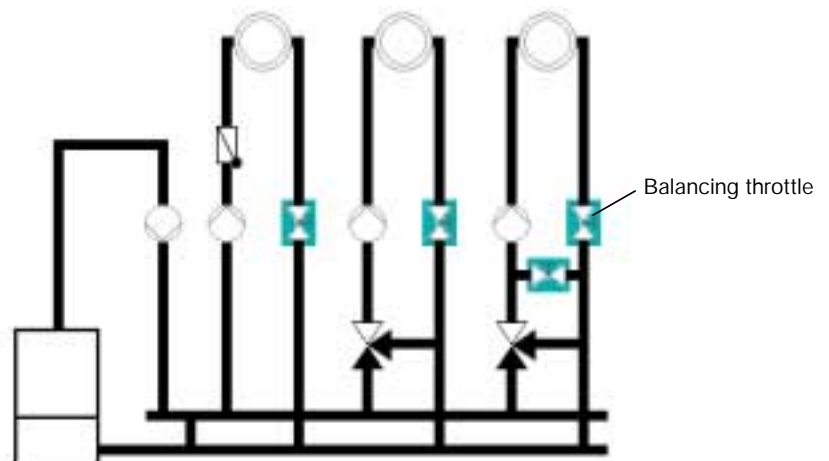

Heating zones with balancing throttles
 (in the piping sections with constant volumetric flow)

1.5.3 Circulating pump

A hydraulic circuit operates correctly only if the circulating pump:

- is correctly sized
- is correctly installed and connected
- operates at the right speed

Also, in certain types of hydraulic circuits, there is a risk of excessive pump temperatures, especially when the pump works against a fully closed valve (also refer to throttling circuits).

In such situations, it is recommended to use speed-controlled pumps or to install a small, adjustable bypass which ensures minimum circulation also when the valve is fully closed.

Also, a pump can be deactivated via an end switch when the valve closes or when a minimum opening position is reached (e.g. $< 2\%$).

1.6 Headers Normally, a heat source delivers heat to several consumers.

The header is used as the connecting element between the heat source and several consumers. It distributes the flow water to the different consumers and collects the return water from them.

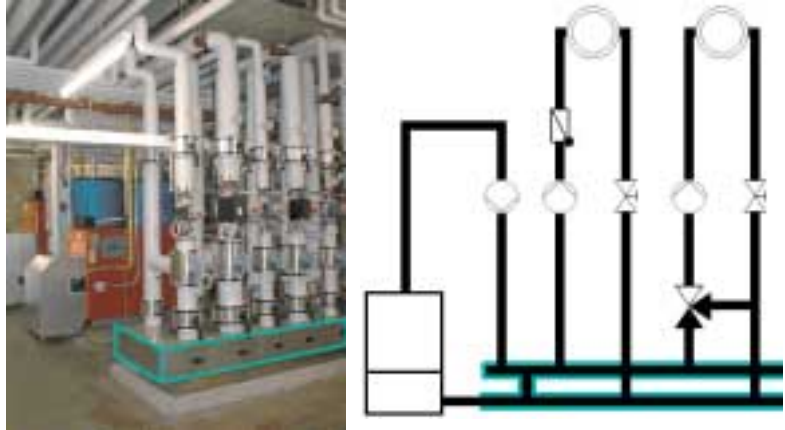

Header as the connecting element between heat source and consumer side

Both the consumer and the heat source side place certain requirements on the header, such as pressure conditions, constant or variable volumetric flow, flow and return temperatures, etc.

To satisfy these requirements, different types of headers are available.

1.6.1 The different types of headers

Headers can be divided into the following categories:

	HEADER			
Main pump	Without main pump (type 1)		With main pump	
Pressure conditions at the header	With pressure		Pressureless (type 4)	
Volumetric flow through the heat source	Variable	Variable (type 2)	Constant (type 3)	Constant
Return temperature to the heat source	Low		High	

The header cannot be looked upon by itself. It is important to use the type of consumer circuit that is suited for the respective type of header. It should also be ensured that consumer circuits with the same (or similar) behavior are used.

1.6.1.1 Header without main pump
(type 1), for consumer zones with mixing circuits

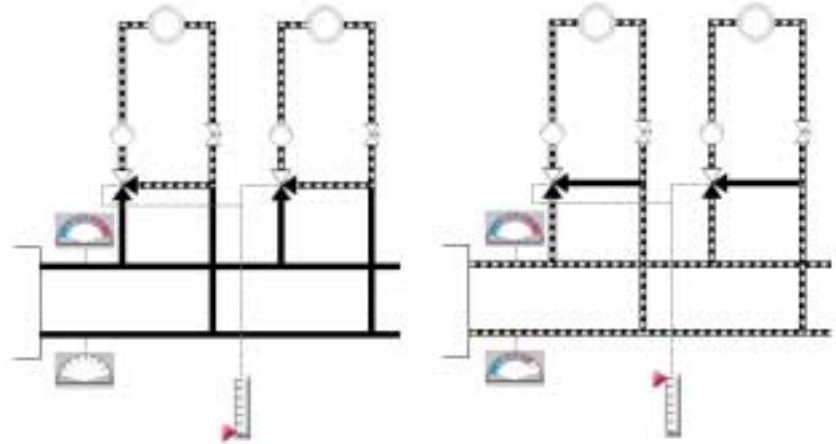

Valves of consumer zones fully closed

Valves of consumer zones fully open

Characteristics

- Low return temperature (between cold and consumer return)
- Volumetric flow through the heat source variable, constant across the consumers
- Consumer zones strongly affect one another (this means that any major change in one of the zones causes pressure changes on the header the effects of which on the other zones must be compensated by them)
- Risk of wrong circulation if, for example, d.h.w. is heated at the end of the header
- The zone pumps must proportionally compensate for the pressure drop in the heat source circuit

Important for troublefree operation

- Heat sources that require a minimum flow rate should not be used
- Maximum pressure drop in the heat source circuit < 20 % of the lowest zone pump head => short and slightly oversized pipes
- Controlling elements of the consumer zones must be correctly sized
- Temperature differential between flow and return of the zones must be maintained (balancing throttle correctly adjusted)

Field of use

- Heat sources that require low return temperatures (e.g. condensing boilers)
- Storage tanks

1.6.1.2 Header with main pump (type 2),
for consumer zones with
throttling circuits or injection circuits
with two-port valves

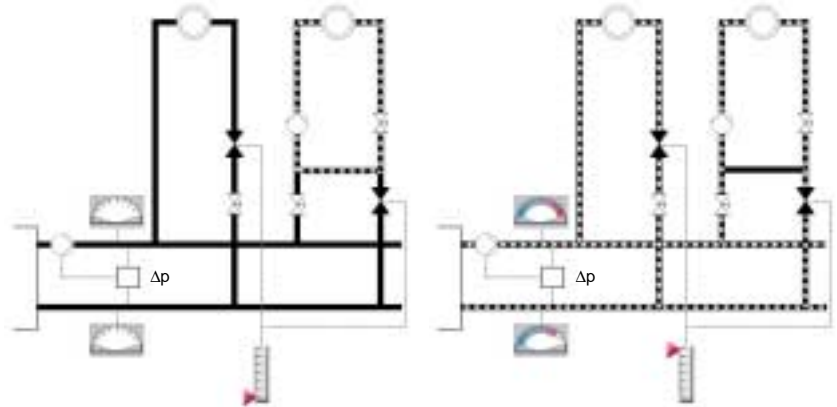

Valves of consumer zones fully closed

Valves of consumer zones fully open

Characteristics

- Low return temperature (consumer return)
- Volumetric flow across the heat source variable

Important for troublefree operation

- Controlling elements of the consumer zones must be correctly sized
- Main pump must be speed-controlled (cuts energy consumption, OFF when there is no load to prevent damage), or adjustable bypass (at the beginning of the header) for minimum circulation (disadvantage: return temperature will be raised again)

Field of use

- D.h.w. storage tank charging
- Supply lines in district heating networks (e.g. in community district heating systems)

1.6.1.3 Header with main pump (type 3),
for consumer zones with
diverting circuits or injection circuits
with three-port valves

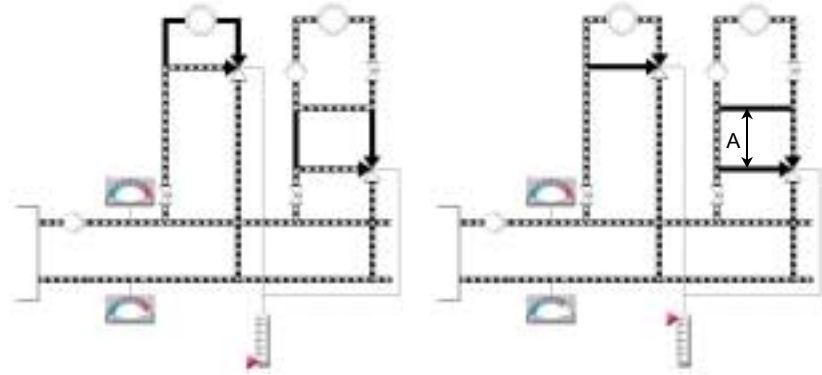

Valves of consumer zones fully closed

Valves of consumer zones fully open

Characteristics

- High return temperature (between consumer return and close to the heat source flow)
- Volumetric flow through the heat source constant
- When using diverting circuits, the main pump must also handle the pressure drop across the consumer
- Hydraulic balancing is difficult
- Later extensions necessitate new hydraulic balancing

Important for troublefree operation

- Controlling elements of the consumer groups must be correctly sized
- To be recommended only if, in terms of pumping power, major consumers can be operated without zone pump (that is with a diverting circuit)
- When using injection circuits, distance A must be a minimum of 10 times the pipe diameter (\Rightarrow sufficient space); otherwise there is a risk of creeping circulation
- Heat source must be suited for high return temperatures

Field of use

- Heat sources with minimum limitation of the return temperature

1.6.1.4 Header with main pump (type 4),
for differential pressureless consumer
connection with mixing circuit

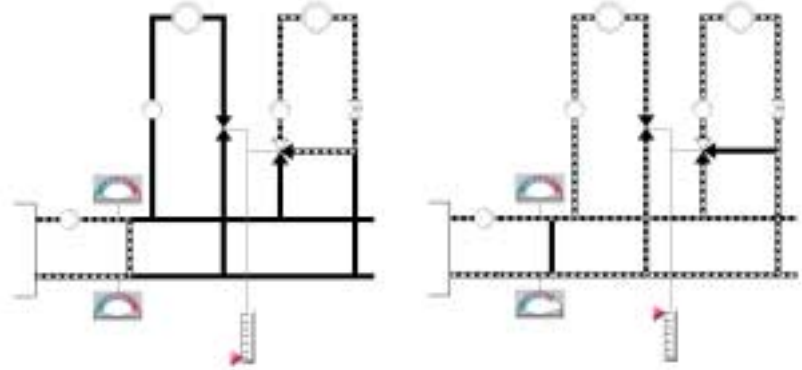

Valves of consumer zones fully closed

Valves of consumer zones fully open

Characteristics

- High return temperature (between consumer return and heat source flow)
- Volumetric flow through the heat source constant
- Clear hydraulic decoupling between heat source and consumer side
- Balancing throttles required only in the consumer circuits (for adjusting the nominal volumetric flow)

Important for troublefree operation

- Header and especially the bypass should be slightly oversized
- Consumer zones with constant or year round heat demand must be connected to the beginning of the header. This prevents an unnecessary flow of water through the header
- Header can be combined with throttling circuit(s), provided their output is small compared to the total output of the header

Field of use

- Heat sources requiring high return temperatures

1.6.1.5 Schematic diagrams of headers

As with the consumer circuits, a distinction is made between 2 types of diagrams, the synoptic diagram and the geographic diagram.

Synoptic diagram

- Flow at the top, hot water
- Return at the bottom, cooler water
- Heat sources in between and the individual consumers connected parallel in the direction of flow

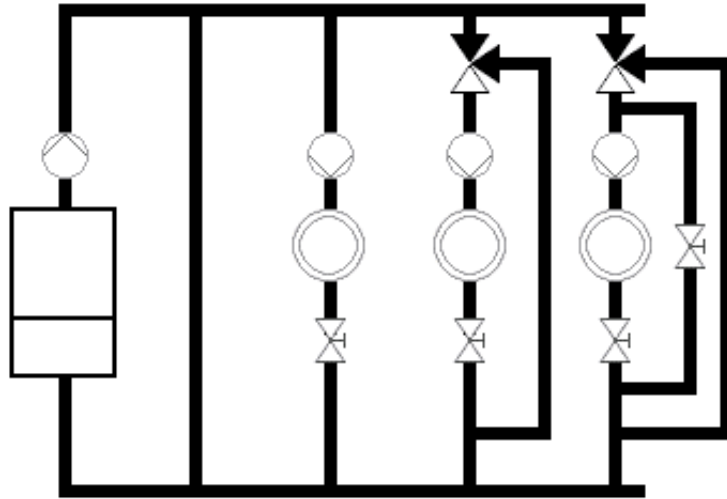

Geographic diagram

Installers and planning engineers often give preference to the geographic diagram which presents the plant the way it is in the boiler room.

From the heat source, flow and return are connected to the header which shows the individual consumer circuits side by side.

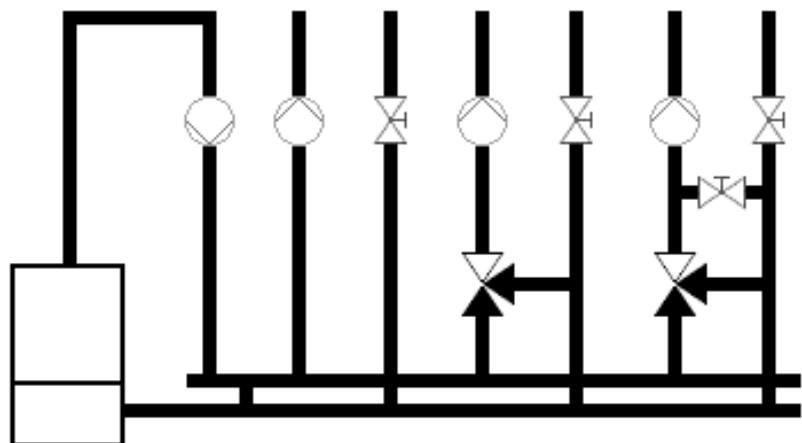

2. Hydraulic characteristics

Parts of the hydraulic circuit also constitute part of the controlled system.

To provide comfortable conditions for the building occupants while ensuring low wear and tear operation of plant, the hydraulic circuits must also satisfy the requirements of control technology.

The combination of characteristics and properties of valves, heat exchangers and pumps in the hydraulic circuit determines whether or not the actuating device (controlling element and actuator) is capable of adequately regulating the plant's heat output.

The actuator converts the controller's positioning signal to a linear or rotary movement of the controlling element so that the volumetric flow passing through it can be changed between 0 and 100 %.

The objective is optimum controllability

The aim is to achieve a linear relationship between valve travel and heat output. In other words, when the valve's travel reaches 50 % of the correcting range, the heat output should be 50 % of the nominal output.

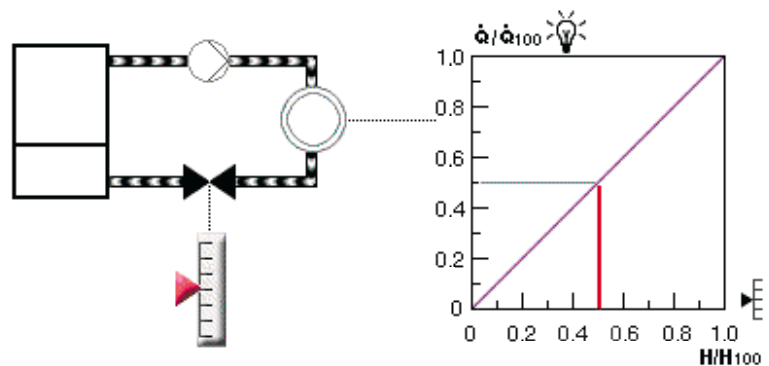

Desired characteristic: 50 % heat output at 50 % valve travel

In practice, however, this characteristic cannot be fully achieved. It is affected by a number of factors a detailed description of which is given in the following.

2.1 Heat exchanger characteristic and a-value

Heat exchanger characteristic

The ratio of volumetric flow of the heat carrier and heat output is dependent on the following factors:

- Design of the heat exchanger
- Temperature differential of water inlet and outlet
- Temperature differential between the heat-absorbing and heat-delivering medium which, as a rule, is not linear

In the case of small volumetric flow, the majority of heat exchanger characteristics are extremely steep. As a result, the radiator temperature will significantly increase even if the amount of hot water passing through the radiator is relatively small.

- Examples:*
- 10 % volumetric flow \Rightarrow 40 % heat output
 - Change from 50 % to 100 % volumetric flow \Rightarrow 15 % more heat output

The initial output surge \dot{Q}_{\min} is the smallest heat output that can be controlled in modulating mode. It is dependent on the starting slope of the heat exchanger characteristic and the valve's rangeability S_V .

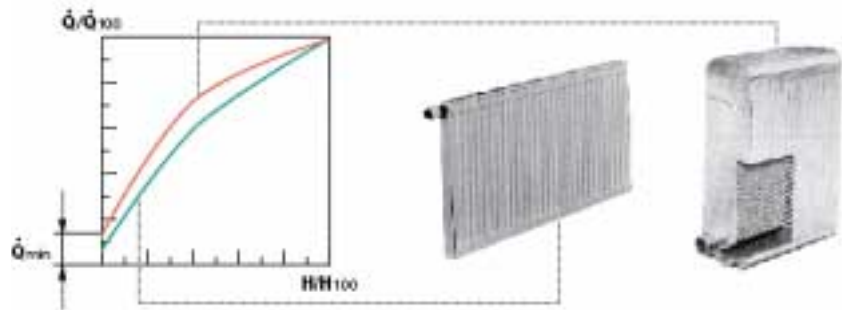

Typical heat exchanger characteristic (example: radiator and heat exchanger for a district heat connection)

a-value The *a-value* is the measure of nonlinearity of a heat exchanger characteristic. It is calculated* based on the temperature conditions at the heat exchanger and is dependent on the type of hydraulic circuit.

Conclusion:

To attain the desired controllability of plant, the inflection of the heat exchanger characteristic must be offset by an appropriate valve characteristic.

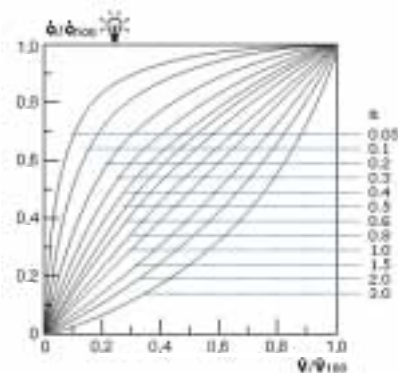

Heat exchanger characteristic with different *a*-values

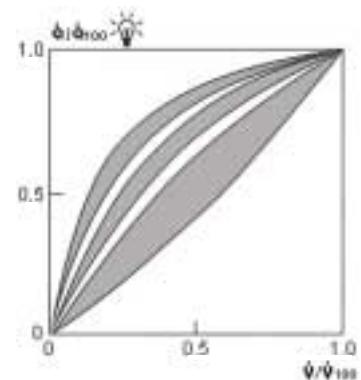

Ranges of typical heat exchanger characteristics:

Top: air cooling coil, variable flow
Middle: radiator
Bottom: heat carrier water / water

- $a\text{-value} = 1 \Rightarrow$ linear characteristic
- $a\text{-value} < 1 \Rightarrow$ upward inflection
- $a\text{-value} > 1 \Rightarrow$ downward inflection

2.2 Valve characteristic

The following parameters are important for determining the valve size:

- The required flow rate
- The pressure drop across the path with variable flow

2.2.1 k_v values

k_v value: flow value at a certain valve stroke

The k_v value of a valve is dependent on the valve's position (stroke). It gives the flow rate at a constant pressure differential of 1 bar across the controlled port.

k_{vS} value: flow value when the valve is fully open

The k_v value resulting from the valve's fully open position (that is, at the nominal stroke H_{100}) is called the k_{vS} value.

The manufacturers of seat valves and throttling valves specify this design-dependent variable k_{vS} for every type of valve.

To be able to compare different makes and types, all valves are specified in a uniform manner:

- k_v values in relation to the k_{vS} value: $k_v / k_{vS} = 0 \dots 1$
- Stroke H in relation to the nominal stroke H_{100} : $H / H_{100} = 0 \dots 1$

If k_v / k_{vS} is shown as a function of the stroke range $0 \dots 1$, the valve characteristic is obtained.

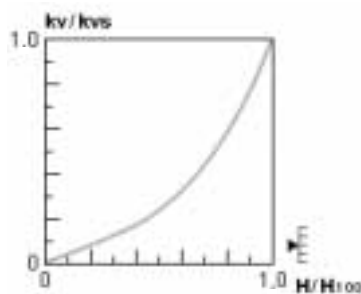

Typical valve characteristic

2.2.2 Rangeability S_V

The rangeability S_V of a valve is the ratio of nominal flow value k_{VS} and smallest controllable flow value k_{VR} .

Rangeability $S_V = k_{VS} / k_{VR}$ (typical values reach from 50 to >150)

The rangeability is an important characteristic that is used to assess the controllable range of a valve and is mainly dependent on the type of valve plug and valve.

The **smallest controllable flow value k_{VR}** is the volumetric flow at the point where the valve suddenly opens, that is, where the valve's characteristic suddenly drops.

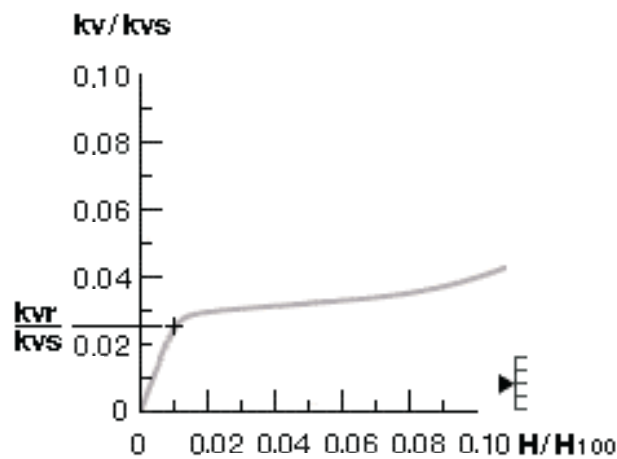

Smallest controllable flow value k_{VR} of a valve

Modulating control below k_{VR} is not possible because the valve only permits volume surges to pass (on / off operation).

2.2.3 The different valve characteristics

A distinction is made between:

- the basic form of the characteristic which is determined mathematically (that is, theoretically), and
- the basic characteristic which represents the flow rate under standard conditions (1 bar, 25 °C), ascertained at each valve position

Linear characteristic

The most common basic forms of characteristics are briefly described in the following:

The same change of stroke produces the same change of k_v value.

Equal-percentage characteristic

The same change of stroke produces the same percentage change of the relevant k_v value, that is, the greater the stroke (the more open the valve), the greater the impact of the stroke change on the volumetric flow. In the lower stroke range, the characteristic is flat. In the upper stroke range, it becomes steeper and steeper.

Equal-percentage / linear characteristic

Basic form of the characteristic that is linear in the lower stroke range and that adopts an equal-percentage characteristic from about 30 % of stroke.

The basic form of the characteristic represents the basis for designing the valve plug which then determines the valve's basic characteristic.

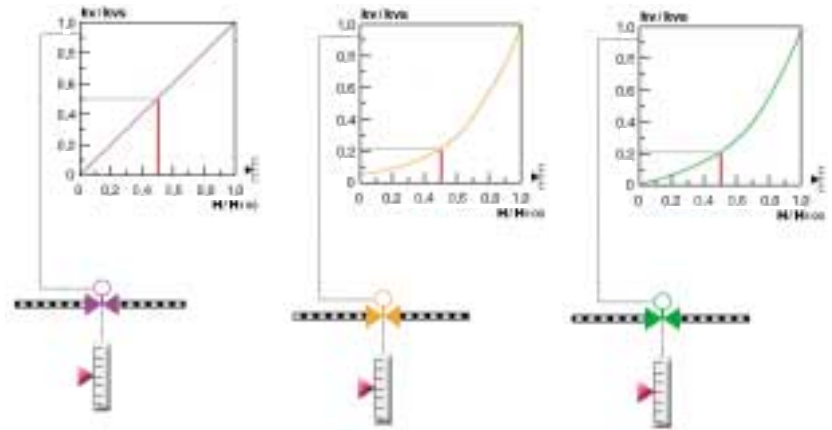

Linear characteristic

Equal-percentage characteristic

Equal-percentage / linear characteristic

Comparison of valve characteristics

2.3 The characteristic of the controlled system

When a valve is installed in a plant, the valve characteristic should offset the heat exchanger characteristic. The resulting output of the heat exchanger can also be shown in the form of a graph, the so-called characteristic of the controlled system or control characteristic.

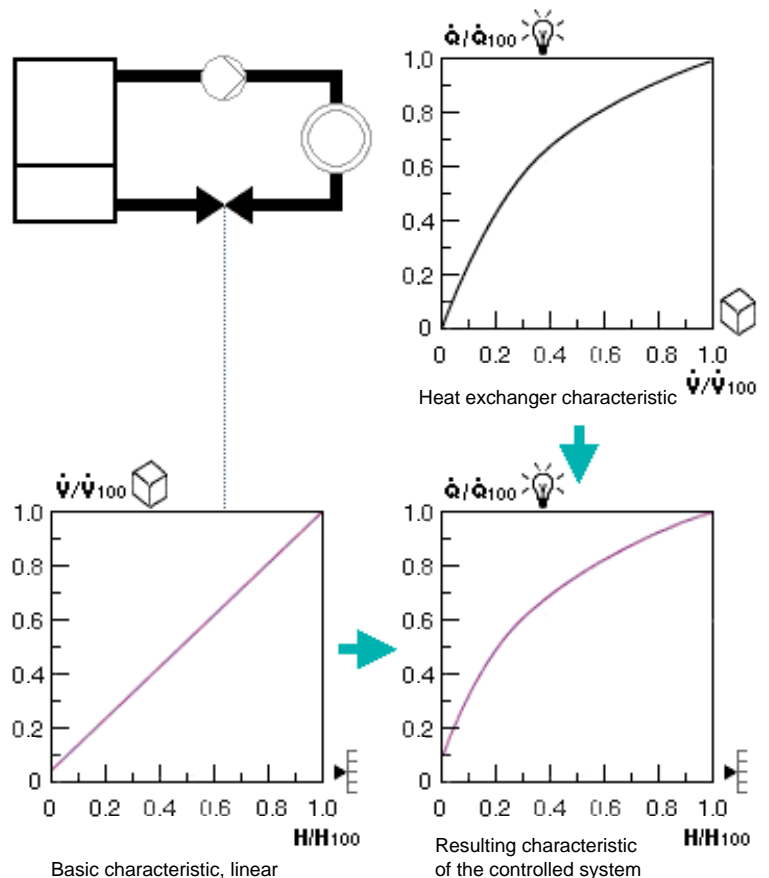

Characteristic of the controlled system as the result of heat exchanger characteristic and valve with a linear basic characteristic

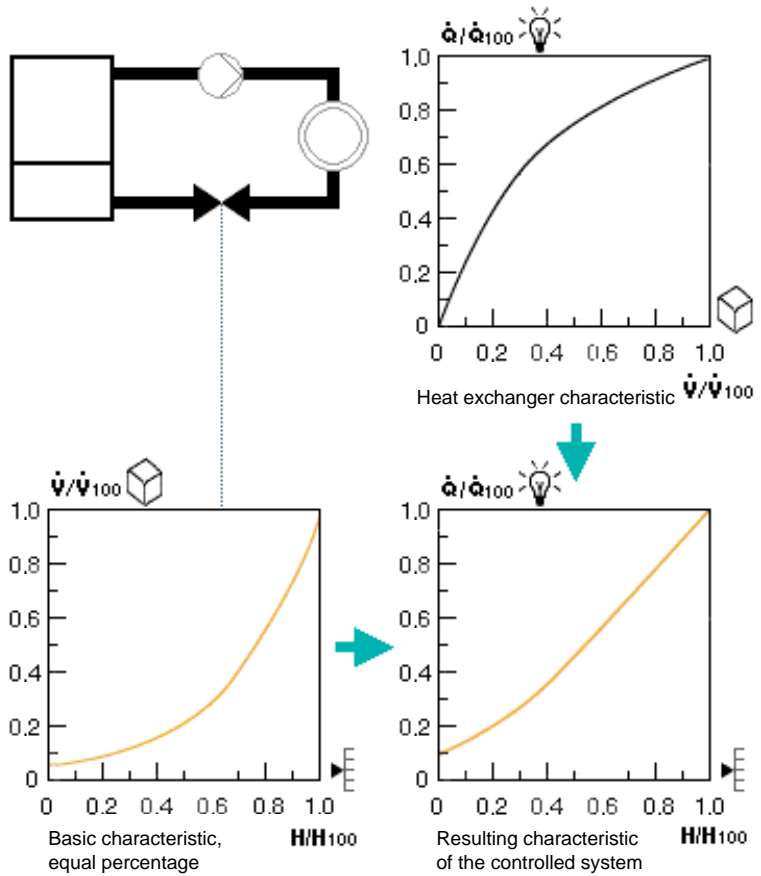

Characteristic of the controlled system as the result of heat exchanger characteristic and valve with an equal-percentage basic characteristic

The graphs above reveal that through adequate selection of the valve characteristic the overall performance will be improved, but this is not enough to achieve a fully linear characteristic.

2.3.1 Valve operating characteristic and valve authority P_V

The characteristic of the controlled system is determined not only by the basic valve characteristic and the heat exchanger characteristic but also by the pressure drop across the valve.

The valve's operating characteristic shows the correlation between stroke and volumetric flow of a valve installed in a hydraulic circuit.

The operating characteristic is different from the valve's basic characteristic since the pressure differential across the valve's entire stroke range is not constant.

The extent of deviation is referred to as the valve authority P_V :
 Valve authority $P_V = \Delta p_{V100} / \Delta p_{V0}$

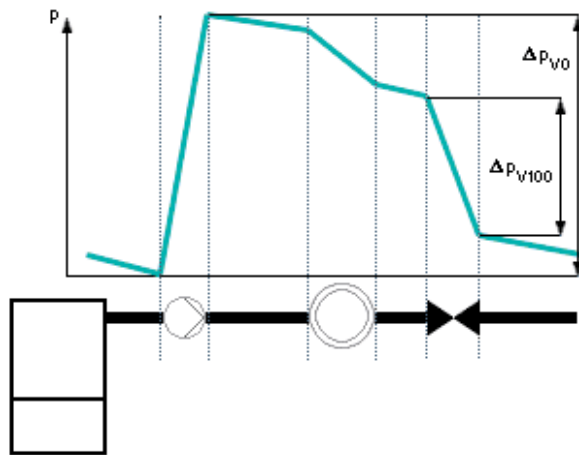

The valve authority P_V is determined by Δp_{V100} and Δp_{V0}

Impact of valve authority on the valve's basic characteristic

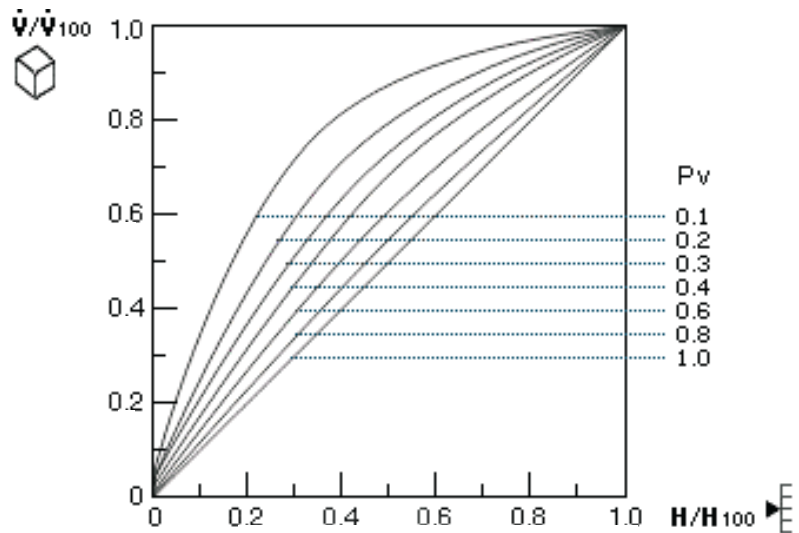

Valve operating characteristics as a function of P_V (example with a linear basic characteristic, that is, $P_V = 1.0$)

The above operating characteristics (example with a linear basic characteristic) show the impact of valve authority $P_V < 1$ on the basic characteristic:

- The smaller the pressure drop Δp_{V100} across the valve in comparison with the affected piping with variable flow, the smaller the valve authority P_V
- The smaller the valve authority P_V , the greater the distortion of the basic characteristic
- If the valve authority $P_V = 1$, the operating characteristic corresponds to the valve's basic characteristic

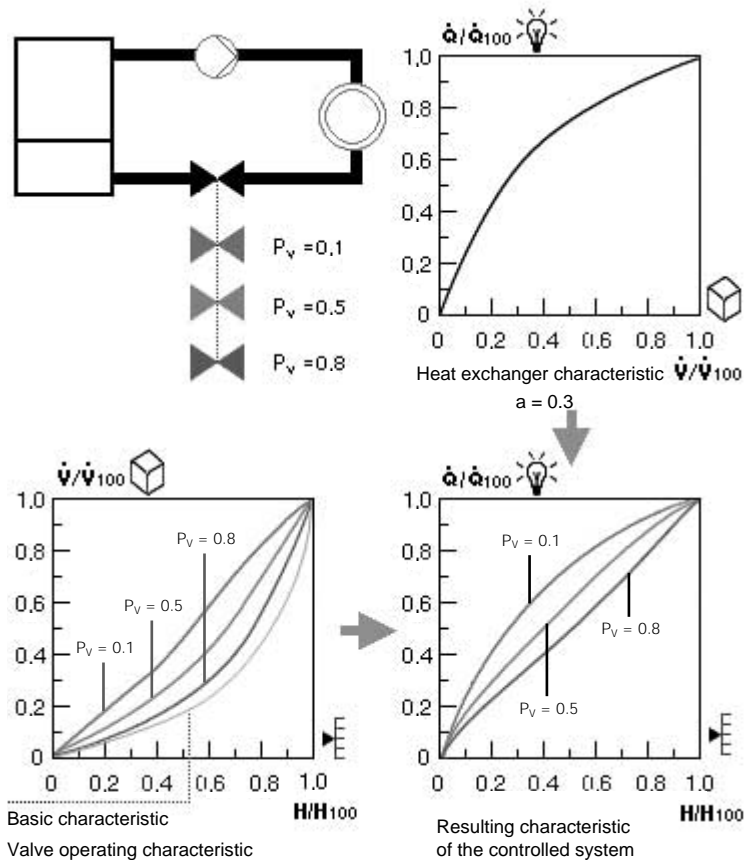

Heat exchanger characteristic, valve operating characteristics and the resulting characteristic(s) of the controlled system

The graph shows which system characteristic results from a heat exchanger characteristic (a -value = 0.3) in combination with different valve operating characteristics.

In the example above, a valve authority of $P_V = 0.8$ produces a nearly linear system characteristic.

2.3.2 Oversized valves

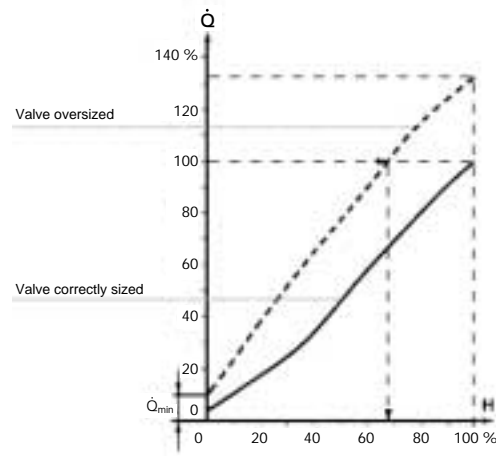

System characteristic with correctly and oversized valve

Consequences of oversizing:

- The minimum controllable output $\dot{Q}_{min.}$ increases
- Since the control limits the stroke according to the required nominal output, the usable correcting span of the valve will be restricted

Due to these effects and the greater minimum controllable output, the plant will become more difficult to control.

Benefits resulting from a correctly sized valve:

- Smaller initial flow surge $\dot{V}_{min.}$, that is, the minimum controllable $\dot{Q}_{min.}$ output will be smaller
- Greater valve authority P_V
- Valve stroke of 0...100 % can be fully used
- The controllability will be considerably improved

Consequences of undersizing:

If a valve is undersized, the required volumetric flow cannot pass through the valve or an unnecessarily high pressure drop in the system occurs, calling for a more powerful pump.

2.3.3 Controlling in the low load range

Initial flow surge \dot{V}_{\min} .

= smallest volumetric flow through a valve that can be controlled in modulating mode

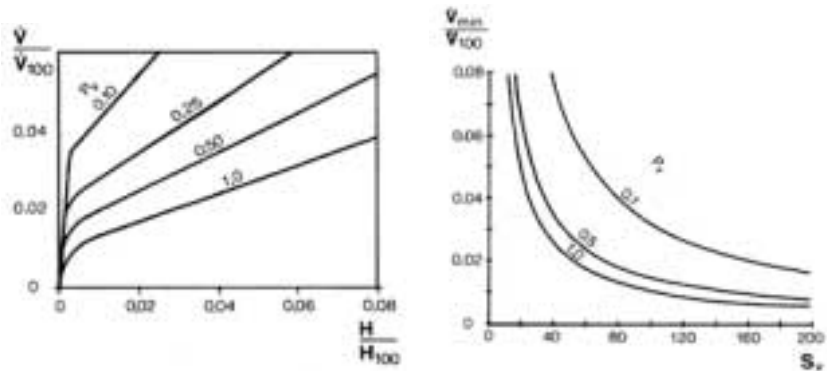

Initial flow surge as a function of valve authority P_V and rangeability S_V

Initial output surge \dot{Q}_{\min} .

= smallest possible output of a consumer (e.g. of a radiator) that can be controlled in modulating mode

The initial output surge becomes the smaller,

- the greater the rangeability S_V of the valve
- the greater the valve authority P_V
- the greater the a -value of the heat exchanger (that is, smaller temperature differentials of heat source and consumer circuit)

2.4 Network and pump characteristic

Network characteristic

The network characteristic shows the correlation between volumetric flow and pressure drop in the hydraulic circuit:

$$\Delta p = \text{const.} \cdot V^2$$

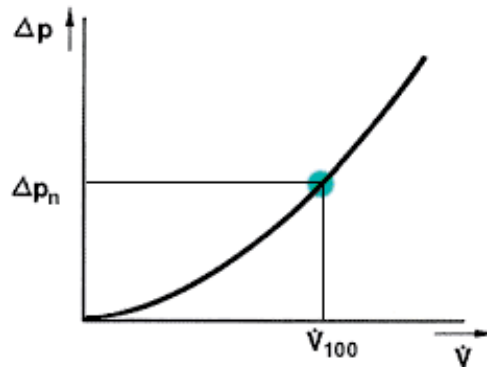

Network characteristic: Δp_n = pressure drop in the piping; \dot{V}_{100} nominal volumetric flow

Pump characteristic

The pump characteristic shows the pump head as a function of the flow. The pump supplier provides this information in the form of a graph:

- The pump head corresponds to the pressure differential between the pump's suction and pressure side
- The flow delivered by the pump corresponds to the volumetric flow (volume per unit of time)

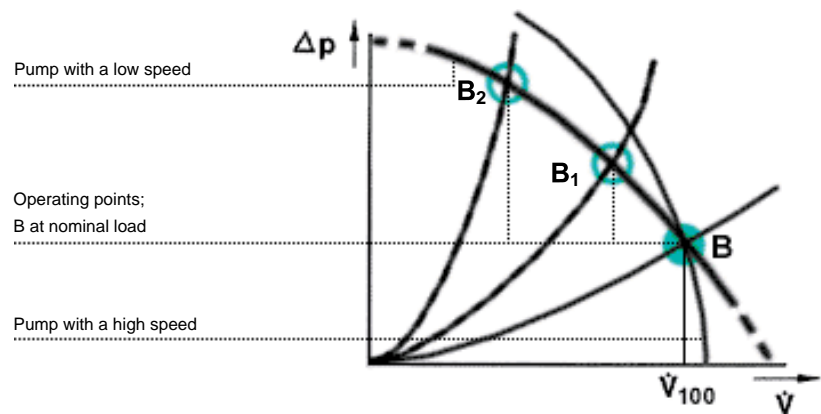

Pump with a high speed

The operating point moves up and down the pump characteristic $B \Rightarrow B_1 \Rightarrow B_2$, depending on the volumetric flow (continuous change of the network characteristic).

The pump characteristics reveal:

The smaller the volumetric flow, the greater the pump pressure.

2.4.1 Parallel operation of pumps

Pumps with a high speed have a steep pump characteristic. When the volumetric flow changes, the pressure in the piping will significantly change. These pressure changes also have an impact on the consumers in the network.

This effect can be reduced by operating two pumps in parallel, since the resulting pump characteristic (P_1 and P_2) will be flatter.

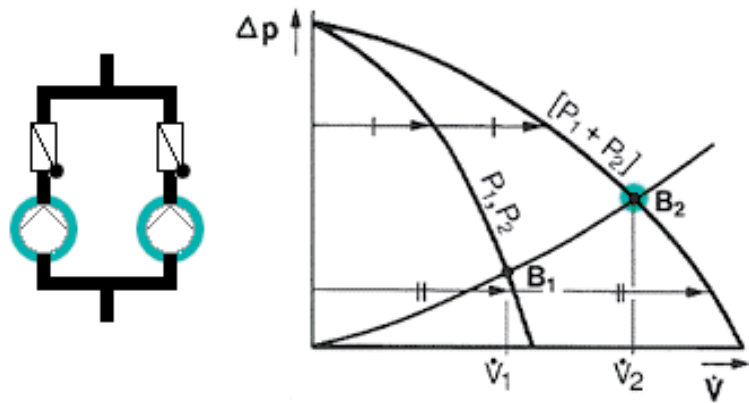

Parallel operation of pumps: B_2 operating point with two pumps (\dot{V}_2)

Parallel operation of pumps is used especially in larger plants with variable volumetric flow.

If the volumetric flow is reduced by deactivating one of the pumps, the pressure drop in the piping will become smaller.

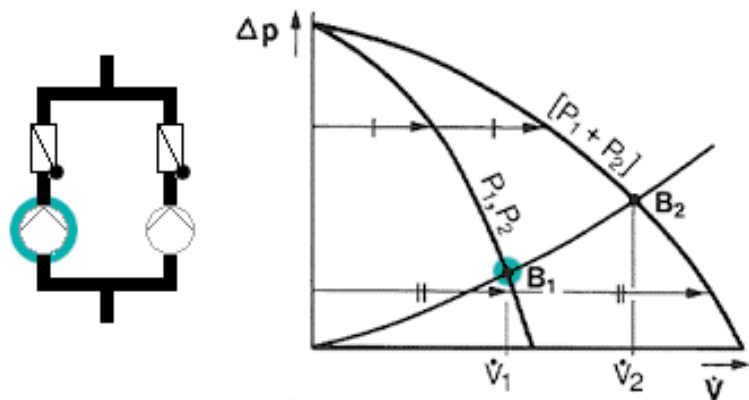

Parallel operation of pumps: B_1 = operating point with one pump (\dot{V}_1)

Today, the adaption to changing operating conditions can also be accomplished by using electronically controlled pumps.

3. Sizing the controlling elements

The previous chapters covered hydraulic circuits, controlling elements and the physical fundamentals of plant. This chapter gives a detailed description of the various aspects of sizing a controlling element.

Before the sizing of actuating devices (controlling elements and actuators) can be tackled and before they can be selected, all important data about the plant must be available:

- The basic diagrams of the hydraulic circuits of both the heat source and consumer side (both geographic and synoptic diagrams)
 - The outputs of the heat source and consumer side with the associated temperature differentials
 - The designations of the heat sources and consumers, e.g. "Heating zone West", "Floor heating new building", "Air heating coil", etc.
- => Information on crucial plant issues

It is also important to know whether the subject hydraulic circuits or control loops (e.g. floor heating systems) are standard or whether special hydraulic circuits are used, making it necessary to gather detailed information about the plant, such as:

- Startup control of a heat pump
- D.h.w. charging with controlled charging temperature
- District heat substations
- Plant sections with high network pressures
- Etc.

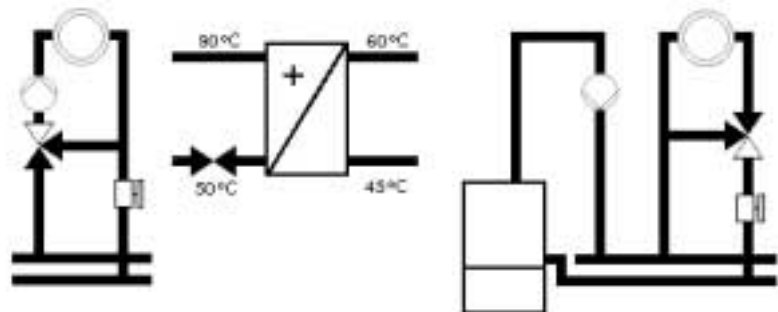

When sizing controlling elements, the different hydraulic circuits and their properties must be taken into account

It is also of utmost importance to know the pressure drops in the part of the piping with variable volumetric flow and across the individual plant components in the hydraulic circuits, such as air heating coils, heat meters, etc. (also refer to section 3.1).

Once all this information is available, the controlling element can be straightforwardly and accurately sized to satisfy plant conditions.

3.1 Piping sections with variable volumetric flow in different hydraulic circuits

When sizing controlling elements, it is very important to correctly identify network sections with variable flow of water (in operation), the reason being that the pressure drop in these sections (with the installed plant components) is an important factor.

In addition to section 1.3, "Consumers with their basic hydraulic circuits", the following diagrams show the sections of individual hydraulic circuits with variable volumetric flow that are decisive for determining the pressure drop. The piping sections with variable flows of water are identified by dotted lines

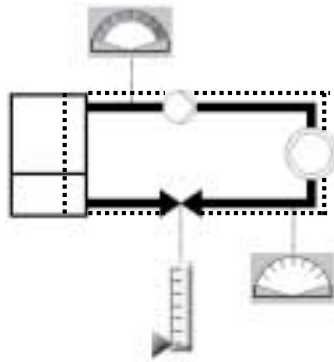

Throttling circuit:
entire piping with heat source
and consumer

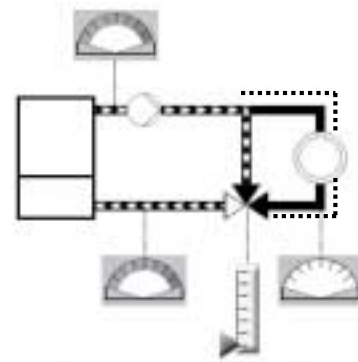

Diverting circuit:
piping via the consumer

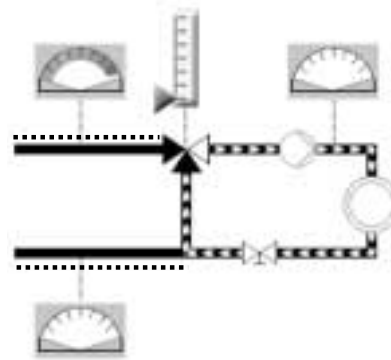

Mixing circuit:
piping from / to the header

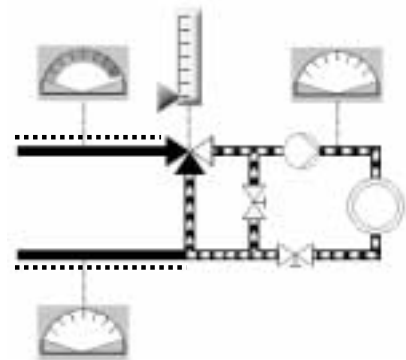

Mixing circuit with fixed premixing:
piping from / to the header

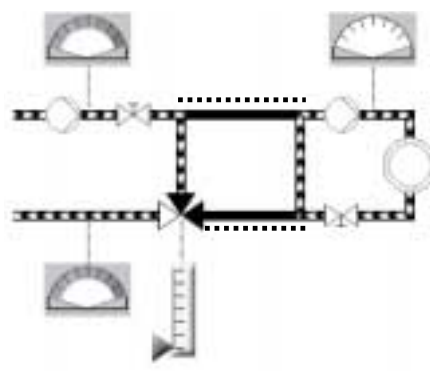

Injection circuit with three-port valve

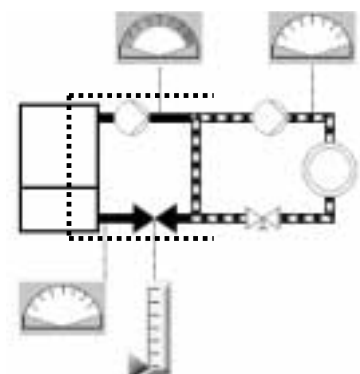

Injection circuit with two-port valve

3.2 Valve sizing example

In a discussion with the planning engineer, you have collected the following information:

<p>Heating boiler</p> <ul style="list-style-type: none"> Flow temperature: 70 °C
<p>Heating zone Old building</p> <ul style="list-style-type: none"> Output: 70 kW Flow temperature: 70 °C Return temperature: 50 °C ⇒ ΔT across consumer: 20 K Mixing circuit Pressure drop in the piping section with variable flow: small (no precise data available) Heat meter fitted in the return
<p>Heating zone New building</p> <ul style="list-style-type: none"> Output: 30 kW Flow temperature: 60 °C Return temperature: 45 °C ⇒ ΔT across consumer: 15 K Mixing circuit with fixed pre-mixing Pressure drop in the piping section with variable flow: small (no precise data available) Heat meter fitted in the return

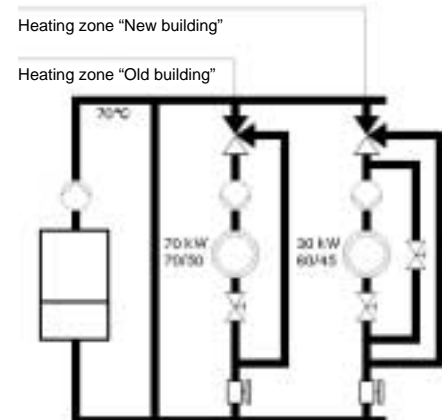

Plant example with heating zones "Old building" and "New building"

3.2.1 Sizing the valve (controlling element) for the heating zone "Old building"

A controlling element is sized by proceeding as follows:

- Ascertain the volumetric flow based on the output and the temperature differential
- Determine the decisive pressure drop in the piping section with variable flow
- Determine the required valve authority P_V for the heating zone
- Determine the k_{VS} value
- Select the valve and the actuator

These steps are discussed below using the example of the heating zone "Old building".

Ascertaining the volumetric flow

The volumetric flow at nominal load, that is, when the control valve is fully open, can be calculated with the following formula:

$$\dot{Q} = \dot{m} \cdot c \cdot \Delta T$$

It can also be determined with the help of a valve slide rule. In our example, the valve slide rule of Siemens is used.

1. Slide line ② with the value of $\dot{Q} = 70 \text{ kW}$ below the value of $\Delta T = 20 \text{ K}$ on line ①
2. Now, you can read the volumetric flow ④ on line \dot{V} :

$$\dot{V} = 3 \text{ m}^3/\text{h} \text{ or } 50 \text{ l}/\text{min}$$

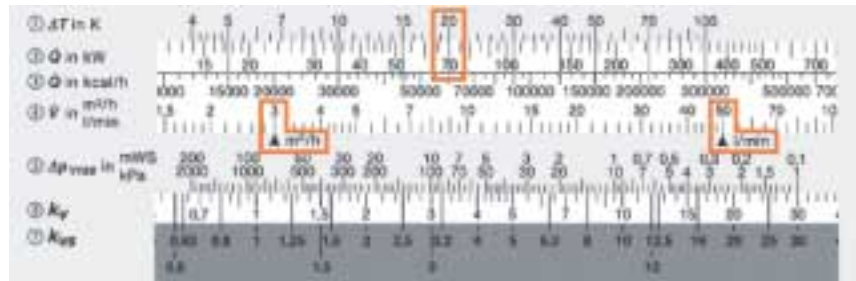

Determination of the volumetric flow at nominal load (controlling element fully open) with the help of the valve slide rule

Hence, this part of the slide rule is based on the formula
 $\dot{Q} = \dot{m} \cdot c \cdot \Delta T$.

Decisive pressure drop in the piping section with variable flow

1. In the hydraulic circuit, determine the piping sections with variable water flow in normal operation.

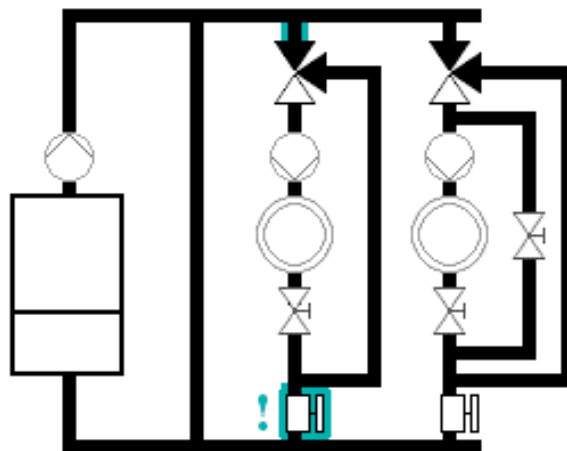

Piping sections with variable water flow in normal operation

2. Determine the pressure drop in the piping sections with variable water flow. The following assumption is made in this example: Pressure drop in the piping sections with variable volumetric flow = 3 kPa.
3. Take into account devices such as heat meters that are fitted in piping sections with variable volumetric flow.

In this example, a heat meter (3 m³/h) is to be taken into consideration. The pressure drop can be obtained from the supplier's specification:

$$\Delta p = 65 \text{ mbar} = 6.5 \text{ kPa}$$

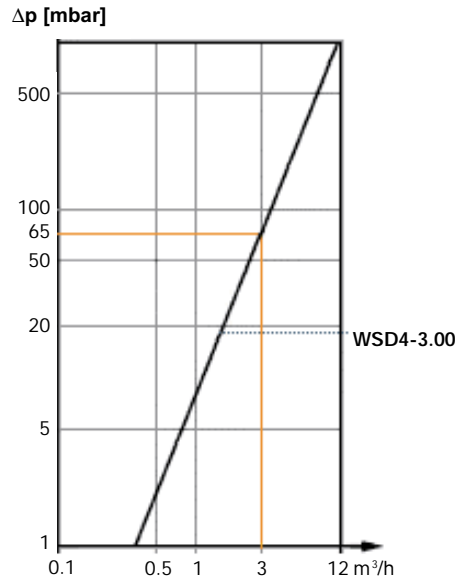

Pressure drop graph of a heat meter

4. Add up all pressure drops in the piping sections with variable volumetric flow and of the plant components contained in those sections.

$$\Delta p_{\text{total}} = 3 \text{ kPa} + 6.5 \text{ kPa} = 9.5 \text{ kPa}$$

Determining the required valve authority P_V

Now, the valve authority P_V required for the heating zone is to be determined. For a heating zone with a mixing circuit, a valve authority of $P_V = 0.5$ is practical.

$P_V = 0.5$ means that the pressure drop Δp_{V100} across the valve is identical to the pressure in the piping sections with variable volumetric flow $\Rightarrow \Delta p_{V100} = 9.5 \text{ kPa}$.

Determining the k_{VS} value

1. Read the k_{VS} value on line ⑦ at Δp_{V100} (line ⑥) = 9.5 kPa.

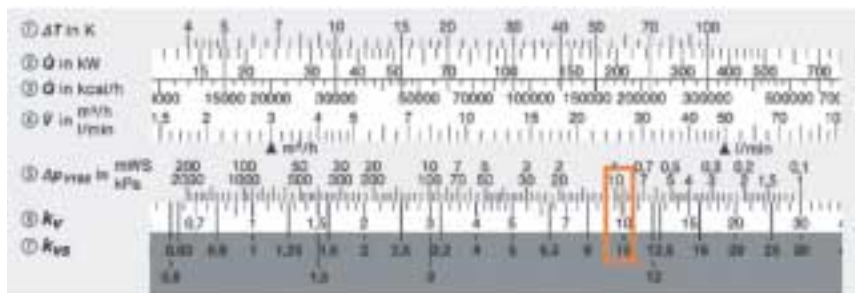

Determination of the k_{VS} value based on Δp_{V100} , using the valve slide rule

Based on a volumetric flow of $3 \text{ m}^3/\text{h}$ (line ④) and $\Delta p_{V100} = 9.5 \text{ kPa}$ (line ⑥), the valve slide rule delivers a k_{VS} value of 10, and thus an effective $\Delta p_{V100} = 9 \text{ kPa}$.

Check briefly the resulting effective valve authority $P_{V\text{eff}}$:

$$P_{V\text{eff}} = \Delta p_{V100} / \Delta p_{V0} = \Delta p_{V100} / (\Delta p_{V100} + \Delta p_D) = 9 \text{ kPa} / (9 + 9.5) \text{ kPa}$$

Resulting valve authority $P_{V\text{eff}} \approx 0.48$

Selecting the valve and the actuator

1. Select suitable valves with a k_{VS} value of 10. For that purpose, slide line ⑩ (k_{VS} value) until the value of 10 appears in the outlined field. Now, you can select the type of valve that suits you.

PN	Designation	Type	max. Temperature	
16 (100)	M3P	3P	120°C	
	M3B	3P	120°C	
	VVG 41	25-10	3P	120°C
	VXG 41	25-10	3P	120°C
	VVG 44	25-10	3P	120°C
	VXG 44	25-10	3P	120°C
	VVF 52	25-10	3P	140°C (180°C)*
25 (1000)	VVF 52	25-10	140°C (180°C)*	

* with special steam sealing **VVF52 see reverse

Choice of valves at a k_{VS} value of 10 m³/h

In our example, you can select a three-port valve VXG41.25-10 or a three-port valve VXG44.25-10.

The actuator to be chosen is a three-position actuator (e.g. SQX32 or SQS35) since there are no special requirements and these types of actuators offer a good price / performance ratio. You will also find suitable combinations of valves and actuators on the valve slide rule or in the technical documentation.

3.3 Special points to be considered when sizing two- and three-port valves

3.3.1 Impact of total volumetric flow and valve authority P_v with three-port valves

Combination of characteristic for three-port valves

The total volumetric flow (AB) on the chart is made up of the volumetric flow through the controlled port (characteristic A) and that through the bypass port (characteristic B).

In practice, two combinations of characteristics are used (controlled port / bypass port):

- Equal-percentage / linear
- Linear / linear

Objective of valve sizing

The objective of sizing a valve is to obtain a control characteristic that is as linear as possible. This necessitates a total volumetric flow AB across the entire stroke as constant as possible.

The total volumetric flow can considerably change, depending on the combination of characteristics and valve authority P_v . For this reason, when sizing a valve, the total volumetric flow and the valve authority P_v (see section 2.3.1) are of utmost importance.

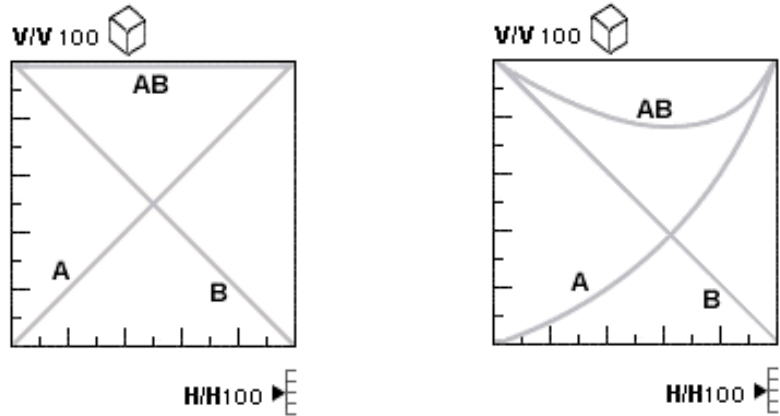

Total volumetric flow (AB) with three-port valves with controlled port (A) and bypass port (B)
 Left: linear / linear characteristic; right: equal-percentage / linear characteristic

Linear / linear combination

The valve authority to be strived for here is as great as possible (P_v approximately 0.9). As a result, the total volumetric flow across the entire stroke range is nearly constant (refer to graph at top right).

Equal-percentage / linear combination

The valve authority P_v selected on the graph at bottom left is about 0.5. As a result, the total volumetric flow across the entire stroke range is nearly constant, thus giving rise to a relatively linear characteristic of the controlled system at medium a-values of 0.4...0.5.

The graph at bottom right shows an example with a great P_v value of about 0.9. In that case, the total volumetric flow in the medium stroke range drops sharply.

At P_v values below 0.4, the total volumetric flow increases sharply.

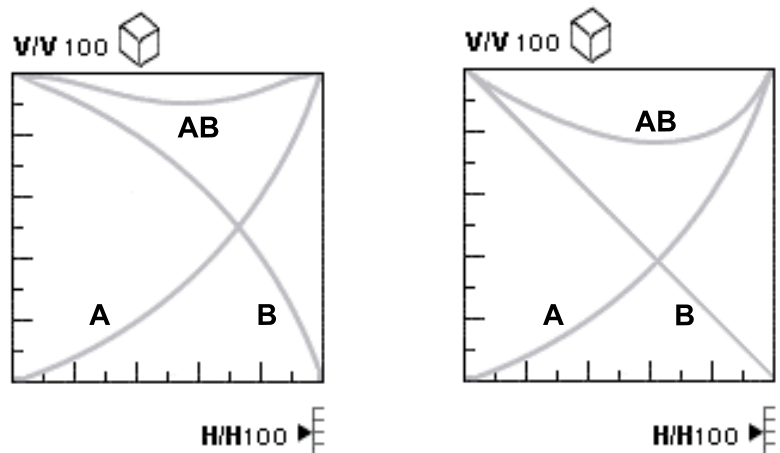

Dependency of the total volumetric flow on the valve authority with equal-percentage / linear characteristics.

Left: $P_v = 0.5$; right: $P_v = 0.9$

3.3.2 Pressure ratios when sizing two-port valves

The basis is the pressure differential Δp_D that is needed for the piping section with the variable flow rate. 50 % of that pressure differential is the pressure drop across the fully opened control valve to achieve a valve authority P_V of 0.5.

Standard applications

In the case of small-scale heating plants with a relatively small pressure drop Δp_D in the influenced piping section with a variable flow rate, a valve authority P_V of about 0.5 is adequate. In other words, the pressure drop Δp_{V100} across the valve must be roughly the same as Δp_D .

Demanding applications

With ventilation and air conditioning plants as well as with more complex heating plants, it is very important to know the pressure drop Δp_D in the fluenced piping section with the variable flow rate. This is required to calculate the respective pressure drop Δp_{V100} across the fully open valve in order to secure the required valve authority P_V .

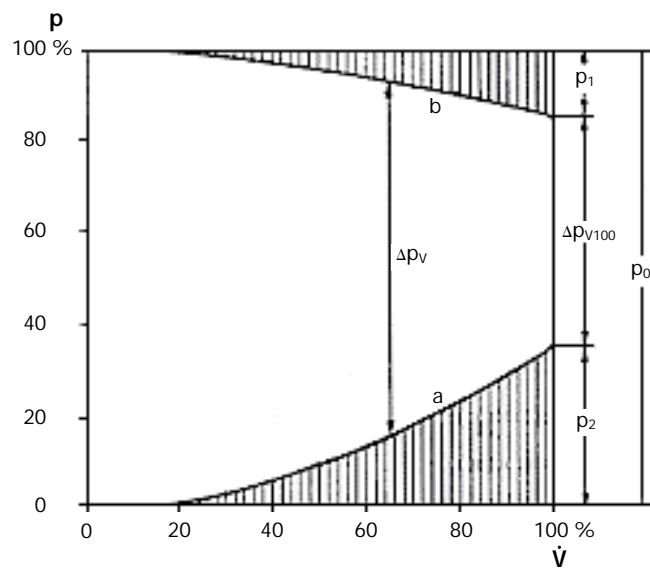
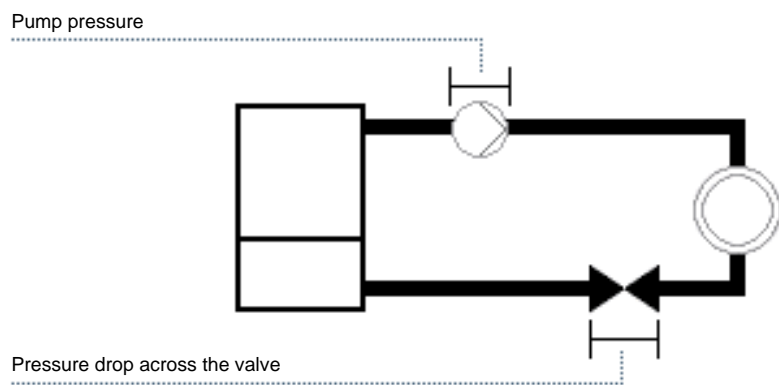

Pressure drop across the two-port valve

- a Characteristic of the piping
- b Pump characteristic
- P Pressure
- V Volumetric flow
- p_0 Maximum pump pressure
- p_1 Pressure drop across the pump
- p_2 Pressure drop in the piping
- Δp_{V100} Pressure drop across the valve

3.4 Example of d.h.w. charging control

The control valve used for this d.h.w. charging control system shall be selected such that the resulting control characteristic is as linear as possible.

The required data such as output, the temperature differentials on the primary and secondary side, and the decisive pressure drop are given in the plant diagram below.

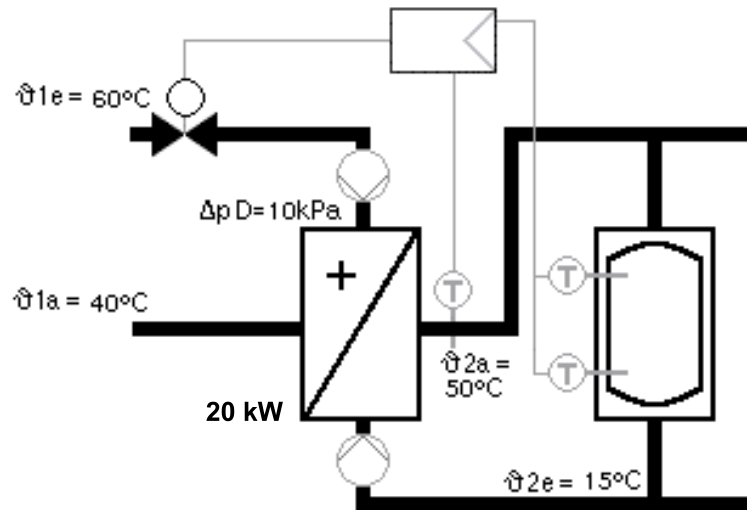

Basic plant diagram of d.h.w. charging control

In order to be able to select a basic valve characteristic and to determine the required valve authority P_v , the a -value of the heat exchanger must be ascertained first.

Calculating the a -value

The a -value is dependent on the temperatures at both sides of the heat exchanger and its design and operating mode which is considered by the factor "f" (also refer to the calculation formulas for the a -value in the Appendix).

Calculation of the a -value:

$$a = f \cdot \frac{(\theta_{1e} - \theta_{1a})}{(\theta_{1e} - \theta_{2a})}$$

The heat exchanger used operates in counterflow mode.

$$\Rightarrow f = 1$$

$$\Rightarrow a = 1 \cdot \frac{(60 - 40) \text{ K}}{(60 - 50) \text{ K}} = 2$$

The calculated a -value of 2 is used now to graphically determine the basic valve characteristic and the required valve authority with the help of graphs.

First, on the graph with the heat exchanger characteristics (for different a -values), the corresponding valves for \dot{Q}/\dot{Q}_{100} and \dot{V}/\dot{V}_{100} will be determined.

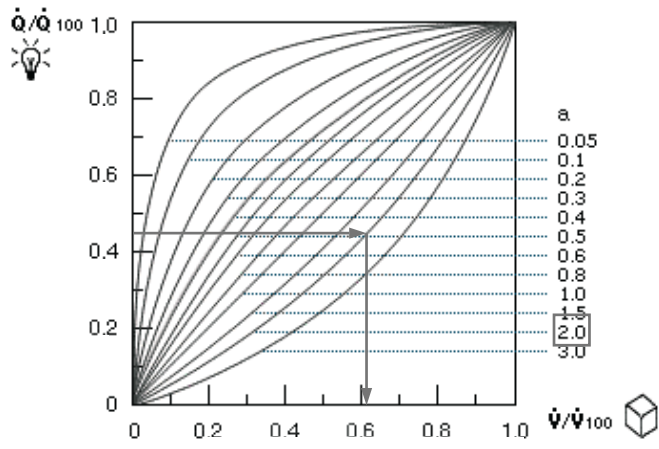

Graph with heat exchanger characteristics (for the different a-values)

For example, an output ratio $\dot{Q}/\dot{Q}_{100} = 0.45$ and an a-value of 2 results in a volumetric flow ratio $\dot{V}/\dot{V}_{100} = 0.62$.

Valve with linear characteristic

To offset the heat exchanger characteristic and to obtain a control characteristic as linear as possible, the valve selected has a linear basic characteristic.

Required valve authority P_v

Required is the valve authority P_v . In order to read it off, you need the chart with the valve's operating characteristics and use the value previously ascertained \dot{V}/\dot{V}_{100} to determine the point of intersection with the stroke ratio $H/H_{100} = 0.45$ (which represents the required linear characteristic).

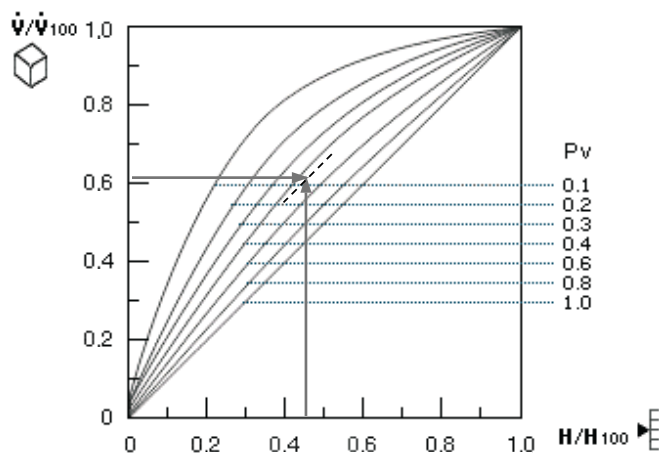

Chart with valve authorities P_v (linear basic characteristic of valve)

For this d.h.w. control system, the valve authority P_v is about 0.45.

Calculating the k_{VS} value

This means that all basic data are now available to calculate the key characteristics Δp_{V100} , and the k_{VS} value that are required for sizing the valve:

$$\Delta p_{V100} = P_V \cdot \Delta p_D / (1 - P_V) = 0.45 \cdot 10 \text{ kPa} / (1 - 0.45)$$

$$\Delta p_{V100} = 8.2 \text{ kPa}$$

$$\dot{V}_{100} = \dot{Q}_{100} \cdot 0.86 / (\vartheta_{1e} - \vartheta_{1a}) = 20 \text{ kW} \cdot 0.86 / 20 \text{ K}$$

$$\dot{V}_{100} = 0.86 \text{ m}^3/\text{h}$$

$$k_{VS} = \dot{V}_{100} \cdot \sqrt{\Delta p_D / \Delta p_{V100}} = 0.86 \cdot \sqrt{100 / 8.2}$$

$$k_{VS} = 3.0 \text{ m}^3/\text{h}$$

The valve slide rule tells us that there is no threaded valve in this range that has the calculated k_{VS} value.

The types of valves available have a k_{VS} value of 2.5 and 4 respectively:

- Variant 1: VVG41.15-4 with a k_{VS} value of 4.0
- Variant 2: VVG41.15-2.5 with a k_{VS} value of 2.5

Available valves with a k_{VS} value of 2.5 and 4

PN	Designation	Type	max. Temperature
15/20	MSP	30°	120°C
15/20	M30	30°	120°C
15/20	VVG41.15-2.5	30°	120°C
15/20	VVG41.15-4	30°	120°C
15/20	VVG44.15-2.5	30°	120°C
15/20	VVG44.15-4	30°	120°C
15/20	VVG46.15-2.5	30°	120°C
15/20	VVG46.15-4	30°	120°C
15/20	VVP43.15	30°	110°C
15/20	VVF52.15-2.5	30°	140°C (180°C)*

Check the effective valve authority

When the valve slide rule is set to the nominal volumetric flow, the resulting pressure drop Δp_{V100} can be read off for both variants so that the effective valve authority P_V can be calculated.

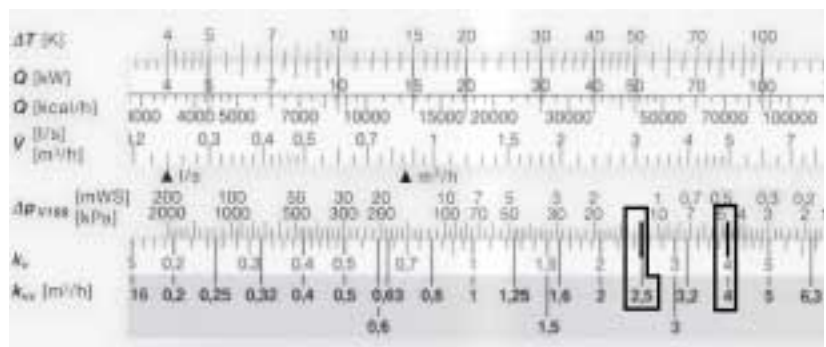

Determine the pressure drop Δp_{V100} at $k_{VS} = 2.5$ or $k_{VS} = 4$ with the help of the valve slide rule

Variant 1:

$$k_{vs}\text{-value} = 4.0 \quad \Rightarrow \Delta p_{V100} = 4.7 \text{ kPa}$$

$$\text{Valve authority } P_{\text{Veff}} = \Delta p_{V100} / (\Delta p_{V100} + \Delta p_D)$$

$$\text{Valve authority } P_{\text{Veff}} = 4.7 / (4.7 + 10) = \mathbf{0.32}$$

Variant 2:

$$k_{vs}\text{-value} = 2.5 \quad \Rightarrow \Delta p_{V100} = 11.7 \text{ kPa}$$

$$\text{Valve authority } P_{\text{Veff}} = \Delta p_{V100} / (\Delta p_{V100} + \Delta p_D)$$

$$\text{Valve authority } P_{\text{Veff}} = 11.7 / (11.7 + 10) = \mathbf{0.54}$$

Using these valve authorities P_{Veff} , the resulting volumetric flow ratios \dot{V}/\dot{V}_{100} can be ascertained from the graph below and compared with the specification.

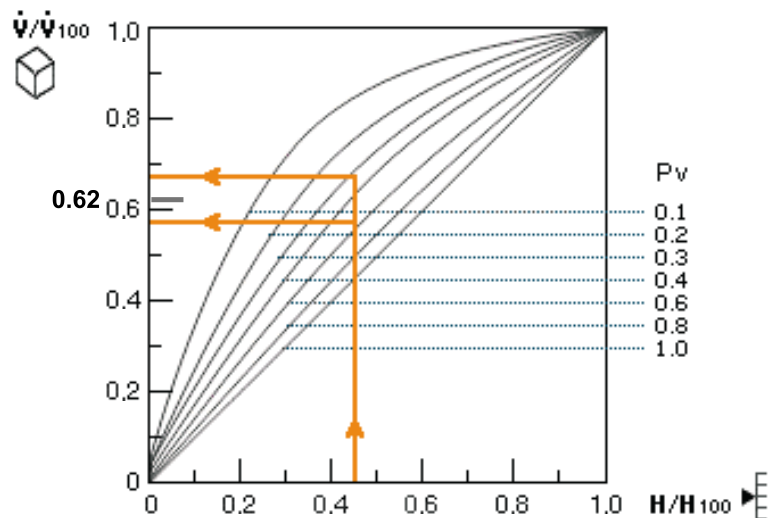

Graph with valve operating characteristics and the resulting valve authorities P_V for $k_{vs} = 2.5$ and 4 respectively

The deviation from the previously ascertained ratio of $\dot{V}/\dot{V}_{100} = 0.62$ is approximately 5 % with both variants.

Final selection of valve

Variant 1 has the smaller pressure drop:

\Rightarrow Use VVG41.15 with a k_{vs} value of 4.0

\Rightarrow Nearly linear characteristic

3.5 Example of air cooling coil control

For an air cooling coil which is controlled on the air side, the selected valve should have a control characteristic as linear as possible.

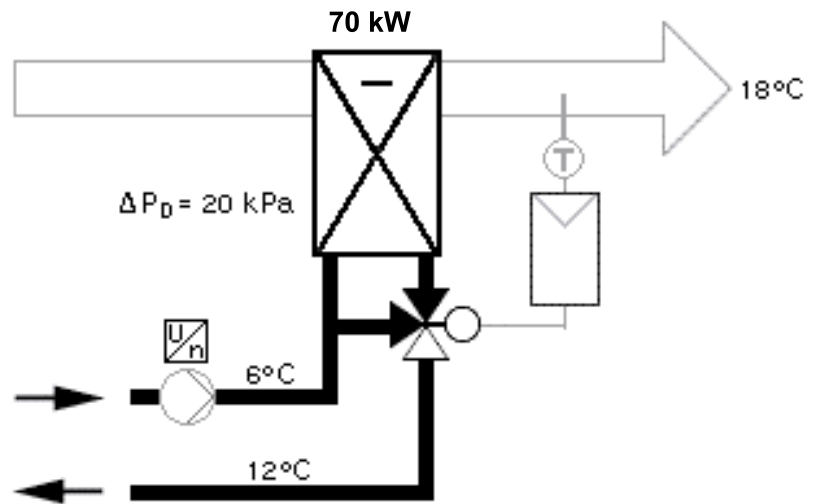

Basic diagram of air cooling coil control

Calculating the a-value

To be able to calculate the a-value, the hydraulic circuit used by the air cooling coil must be known, because the f-factor depends on the type of hydraulic circuit.

In our example, the hydraulic circuit used is a diverting circuit which enables the air cooling coil to always operate on the same low cooling water flow temperature.

For an air cooling coil connected to a diverting circuit (volumetric flow control), factor $f = 0.6$ is to be used when calculating the a-value (refer to Appendix).

Calculation of a-value:

$$a = 0.6 \cdot \frac{(\vartheta_{1e} - \vartheta_{1a})}{(\vartheta_{1e} - \vartheta_{2a})} = 0.6 \cdot \frac{(6 - 12)\text{K}}{(6 - 18)\text{K}} = 0.3$$

The basic valve characteristic and the valve authority P_v are determined the way as explained in the example with d.h.w. charging control.

Again, we select a value in the medium slope range of the heat exchanger characteristic $a = 0.3$, e.g. $\dot{Q}/\dot{Q}_{100} = 0.6$.

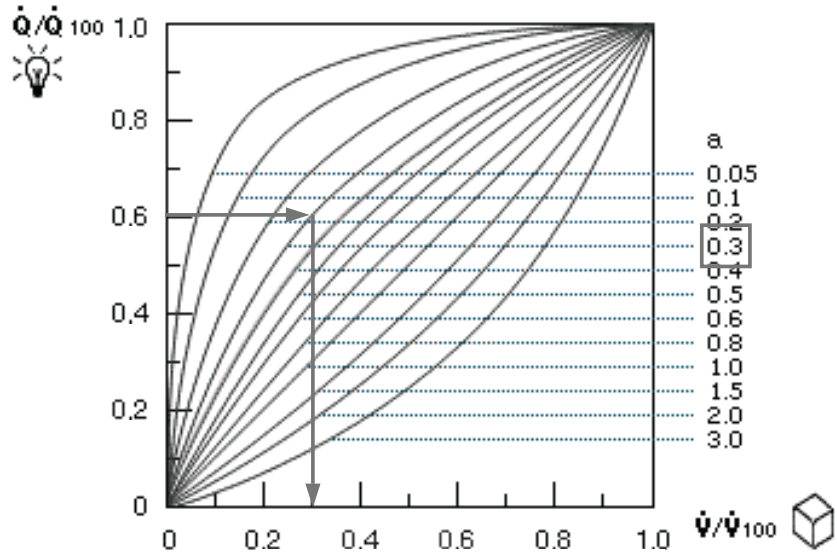

Graph with heat exchanger characteristics (for different a-values)

For an air cooling coil, the volumetric flow ratio $\dot{Q}/\dot{Q}_{100} = 0.6$ is 0.3, for example, for an output ratio $\dot{V}/\dot{V}_{100} = 0.32$ and an a-value of 0.3.

Valve with equal-percentage characteristic

To offset this extremely nonlinear heat exchanger characteristic and to obtain a control characteristic as linear as possible, the valve selected has an equal-percentage basic characteristic.

Required valve authority P_v

Now, use the graph with the valve operating characteristics to determine the optimum valve authority P_v . It is at the point of intersection with the stroke ratio $H/H_{100} = 0.6$ of 0.6 (corresponding to the required linear characteristic).

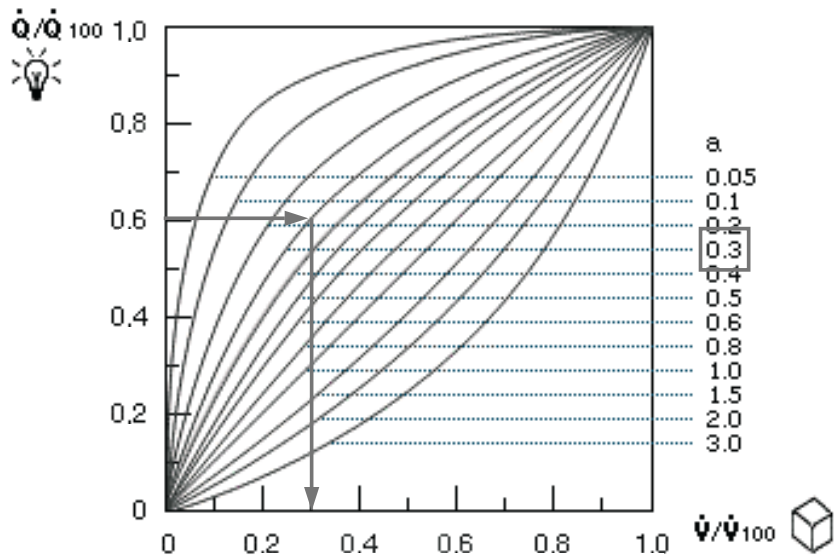

Graph with the valve authorities P_v (equal-percentage basic characteristic of valve)

The valve authority P_v for this air cooling coil control is thus approximately 0.9.

Calculating the k_{VS} value

This means that all basic data required for calculating the key characteristics Δp_{V100} are now available, \dot{V}_{100} and the k_{VS} value required for sizing the valve:

$$\Delta p_{V100} = P_V \cdot \Delta p_D / (1 - P_V) = 0.9 \cdot 20 \text{ kPa} / (1 - 0.9)$$

$$\Delta p_{V100} = 180 \text{ kPa} \Rightarrow \text{this value is too high! (in relation to } \Delta p_D = 20 \text{ kPa)}$$

From the theory described above, we know that with three-port valves, the selected valve authority P_V should be about 0.5 because this produces a fairly constant total volumetric flow (resulting from the controlled port and the bypass port).

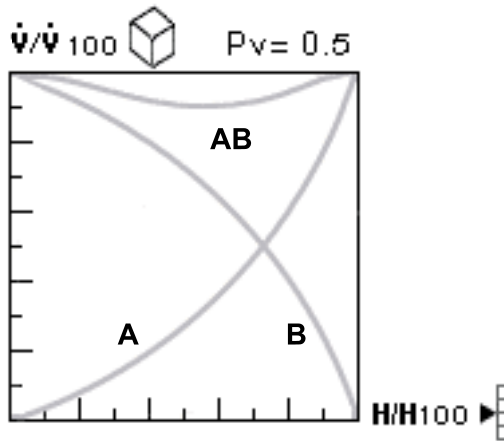

Total volumetric flow (AB) of a three-port valve with a valve authority P_V of 0.5

Δp_{V100} , \dot{V}_{100} and the theoretical k_{VS} value can now be calculated as before:

$$\Delta p_{V100} = P_V \cdot \Delta p_D / (1 - P_V) = 0.5 \cdot 20 \text{ kPa} / (1 - 0.5)$$

$$\Delta p_{V100} = 20 \text{ kPa}$$

$$\dot{V}_{100} = \dot{Q}_{100} \cdot 0.86 / (\vartheta_{1e} - \vartheta_{1a}) = 70 \text{ kW} \cdot 0.86 / 6 \text{ K}$$

$$\dot{V}_{100} = 10.0 \text{ m}^3/\text{h}$$

$$k_{VS} = \dot{V}_{100} \cdot \sqrt{\Delta p_D / \Delta p_{V100}} = 10.0 \cdot \sqrt{100/20}$$

$$k_{VS} = 22.4 \text{ m}^3/\text{h}$$

The valve slide rule tells us that two valves are available for selection, a valve with a k_{VS} value of 19 (\Rightarrow VXF21.40) and a valve with a k_{VS} value of 31 (\Rightarrow VXF21.50).

		PN		
		12	18	25
		40		
PN	Designation	Type	max. Temperature	
8	VXF 21	40-18	D=1	120°C
8	VXF 21	40-18	D=2	120°C
18	M3P	18-18	D=1	120°C
	VXF 41	40-18	D=1	120°C / 180°C
	VXF 41	40-18	D=2	120°C / 180°C
	M3P	18-18	D=1	120°C
25	VXF 45	—	D=1	140°C / 180°C
40	VXF 51	40-18	D=1	220°C
40	VXF 51	40-18	D=2	220°C

* with special steam sealing **VXF52 see reverse

Available valves with a k_{VS} value of 19 and a k_{VS} value of 31

When the valve slide rule is set to the nominal volumetric flow $\dot{V}_{100} = 10.0 \text{ m}^3/\text{h}$, the resulting pressure drop Δp_{V100} can be read off for both variants so that the effective valve authority P_{Veff} can be calculated:

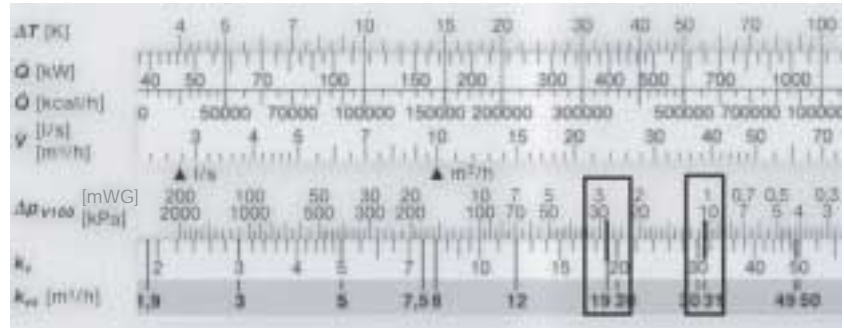

Determine the pressure drop Δp_{V100} at $k_{vs} = 19$ or 31 with the help of the valve slide rule

Variant 1:

$k_{vs}\text{-value} = 19 \quad \Rightarrow \Delta p_{V100} = 28 \text{ kPa}$

Valve authority $P_{\text{Veff}} = \Delta p_{V100} / (\Delta p_{V100} + \Delta p_D)$

Valve authority $P_{\text{Veff}} = 28 / (28 + 20) = 0.58$

Variant 2:

$k_{vs}\text{-value} = 31 \quad \Rightarrow \Delta p_{V100} = 10.5 \text{ kPa}$

Valve authority $P_{\text{Veff}} = \Delta p_{V100} / (\Delta p_{V100} + \Delta p_D)$

Valve authority $P_{\text{Veff}} = 10.5 / (10.5 + 20) = 0.34$

The deviation from the value of $\dot{V}/\dot{V}_{100} = 32 \%$ ascertained before can be determined from the graph with the valve operating characteristics and gives the following percentages:

- At k_{vs} value 19 ($P_{\text{Veff}} = 0.58$) $\approx 5 \%$
- At k_{vs} value 31 ($P_{\text{Veff}} = 0.34$) $\approx 15 \%$

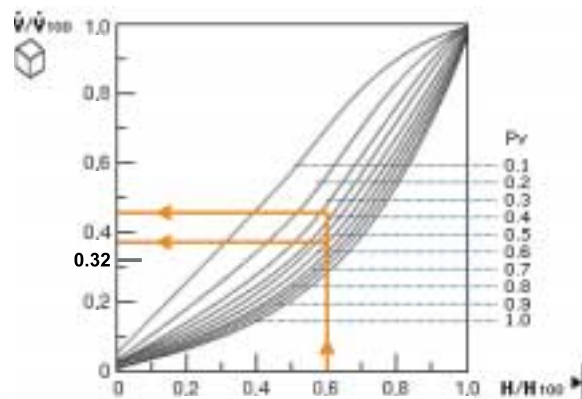

Graph with valve operating characteristics and the resulting valve authorities P_V for $k_{vs} = 19$ and 31 respectively

Final selection of valve **Variant 1** has the better linearity and is more favorably priced but produces a greater pressure drop which, in this example, is acceptable.

=> Use VXF21.40 with a k_{vs} value of 19

Definition of a-value:

- General:

$$a = f \cdot \frac{(\vartheta 1_e - \vartheta 1_{a100})}{(\vartheta 1_e - \vartheta 1_{a0})}$$

- For practical applications (under near zero load conditions):

$$a = f \cdot \frac{\Delta T_{\text{primär bei Vollast}}}{\Delta T_{\text{primär bei } \dot{V}_0 = \dot{V}_{\text{min}} > 0}}$$

Formulas used for calculating the a-value:
(select formula that suits your application)

- For radiators:
Use a-value as stated in the supplier's specification
(range from about 0.5 ... 0.65)

- For mixing circuits, water => water (f = 1):

ϑ2_a not controlled, ϑ2_e constant: ϑ2_a controlled:

$$a = \frac{(\vartheta 1_e - \vartheta 1_{a100})}{(\vartheta 1_e - \vartheta 2_e)} \qquad a = \frac{(\vartheta 1_e - \vartheta 1_{a100})}{(\vartheta 1_e - \vartheta 2_a)}$$

- Flow temperature control (e.g. mixing circuit), a = 1

- For mixing circuit, water => air (f = 1):

Air outlet temperature, controlled: Room temperature, controlled:

$$a = \frac{(\vartheta 1_e - \vartheta 1_{a100})}{(\vartheta 1_e - \vartheta 2_a)} \qquad a = \frac{(\vartheta 1_e - \vartheta 1_{a100})}{(\vartheta 1_e - \vartheta 2_e)}$$

- For flow control, water => water (f: parallel flow = 2; counterflow = 1):

ϑ2_a not controlled, ϑ2_e constant: ϑ2_a controlled:

$$a = f \cdot \frac{(\vartheta 1_e - \vartheta 1_{a100})}{(\vartheta 1_e - \vartheta 2_e)} \qquad a = f \cdot \frac{(\vartheta 1_e - \vartheta 1_{a100})}{(\vartheta 1_e - \vartheta 2_a)}$$

- For flow control, water => air (f = 0.6):

Air outlet temperature, controlled: Room temperature, controlled:

$$a = 0.6 \cdot \frac{(\vartheta 1_e - \vartheta 1_{a100})}{(\vartheta 1_e - \vartheta 2_a)} \qquad a = 0.6 \cdot \frac{(\vartheta 1_e - \vartheta 1_{a100})}{(\vartheta 1_e - \vartheta 2_e)}$$

Legend:

- \dot{V}_0 Minimum volumetric flow that can be adjusted on the primary side, $\dot{V}_{\text{min}} > 0$.
- $\vartheta 1_e$ Primary inlet temperature upstream of the controlling element
- $\vartheta 1_{a100}$ Primary outlet temperature at \dot{V}_{100}
- $\vartheta 1_{a0}$ Primary outlet temperature at \dot{V}_0
- $\vartheta 2_e$ Secondary inlet temperature
- $\vartheta 2_a$ Secondary outlet temperature
- f Design-dependent correction factor of the heat exchanger (also refer to documentation provided by CBT)

<i>Index</i>	actuating device	16
	• actuator	16
	• controlling element	16
	actuator	42
	a-value	25, 26, 45, 49
	balancing throttle	17
	basic hydraulic circuits	8
	• diverting circuit	9, 11
	• injection circuit	9, 14
	• mixing circuit	9, 12
	• throttling circuit	9, 10
	basic valve characteristic	
	• impact of valve authority P_v	31
	characteristic of the controlled system	29
	circulating pump	18
	constant volumetric flow	12
	control of mixing	9
	control of the flow	9
	controlling element	7
	diverting circuit	9, 11, 38
	geographic diagrams	6, 10, 11, 12, 13, 14, 15, 24
	header	19
	• with main pump (pressureless)	21
	• with main pump (pressurized)	22
	• with main pumps (pressurized)	23
	• without main pump	20
	heat exchanger characteristic	25
	hydraulic balancing	17
	injection circuit	9, 14, 15, 38
	k_v	27
	k_v values	27, 41, 47, 51, 52
	mixing circuit	9, 12, 38
	network characteristic	35
	pump characteristic	35
	rangeability S_v	28
	schematic diagrams of headers	24
	sizing controlling elements	
	• two-port valves	54
	sizing the controlling elements	37
	• ascertaining the volumetric flow	39
	synoptic diagrams	7, 10, 11, 12, 13, 14, 15, 24
	the different hydraulic circuits	6
	• geographic diagram	6
	• synoptic diagram	7
	the different valve characteristics	28
	• equal-percentage	28, 29, 43, 50
	• equal-percentage / linear	29, 43
	• linear	29, 43, 46
	three-port valve	14, 16
	• impact of total volumetric flow and valve authority P_v	41
	throttling circuit	9, 10, 38
	two-port valve	15, 16
	• pressure ratios	44
	valve authority P_v	31, 32, 41, 42, 46, 50
	• impact on valve's basic characteristic	31, 42
	valve characteristic	27
	variable volumetric flow	37



References

This brochure is an extract of the training module
"B04HV-de – Hydraulics in building systems" produced by

Siemens Building Technologies
Building Automation
Sales and Application Training
Gubelstrasse 22
CH-6301 Zug



Siemens Building Technologies AG

HVAC Products
Gubelstrasse 22
CH-6301 Zug
Tel. +41 41 724 24 24
Fax +41 41 724 35 22

Siemens Building Technologies Ltd.

HVAC Products
Hawthorne Road
Staines
Middlesex TW18 3AY
England
Tel. +44 1784 46 16 16
Fax +44 1784 46 46 46

Siemens Building Technologies Ltd.

HVAC Products
16/F, Laford Center
838 Lai Chi Kok Road
Kowloon, Hong Kong
Tel. +852 2856 3813
Fax +852 2564 4254

Siemens Building Technologies

www.landisstaefa.com